

This document was generated by me Colin Hinson from a document held at Henlow Signals Museum. It is presented here (for free) and this version of the document is my copyright (along with the Signals Museum) in much the same way as a photograph would be. Be aware that breach of copyright can result in a criminal record.

The document should have been downloaded from my website <https://blunham.com/Radar>, if you downloaded it from elsewhere, please let me know (particularly if you were charged for it). You can contact me via my Genuki email page:

<https://www.genuki.org.uk/big/eng/YKS/various?recipient=colin>

**You may not** copy the file for onward transmission of the data nor attempt to make monetary gain by the use of these files. If you want someone else to have a copy of the file, please point them at the website (<https://blunham.com/Radar>).

**Please do not** point them at the file itself as the file may move or be updated.

---

I put a lot of time into producing these files which is why you are met with this page when you open the file.

In order to generate this file, I need to scan the pages, split the double pages and remove any edge marks such as punch holes, clean up the pages, set the relevant pages to be all the same size and alignment. I then run Omnipage (OCR) to generate the searchable text and then generate the pdf file.

Hopefully after all that, I end up with a presentable file. If you find missing pages, pages in the wrong order, anything else wrong with the file or simply want to make a comment, please drop me a line (see above).

It is my hope that you find the file of use to you personally – I know that I would have liked to have found some of these files years ago – they would have saved me a lot of time !

Colin Hinson

In the village of Blunham, Bedfordshire.



F3 MAINS IN

R 3106A RECEIVER FRONT

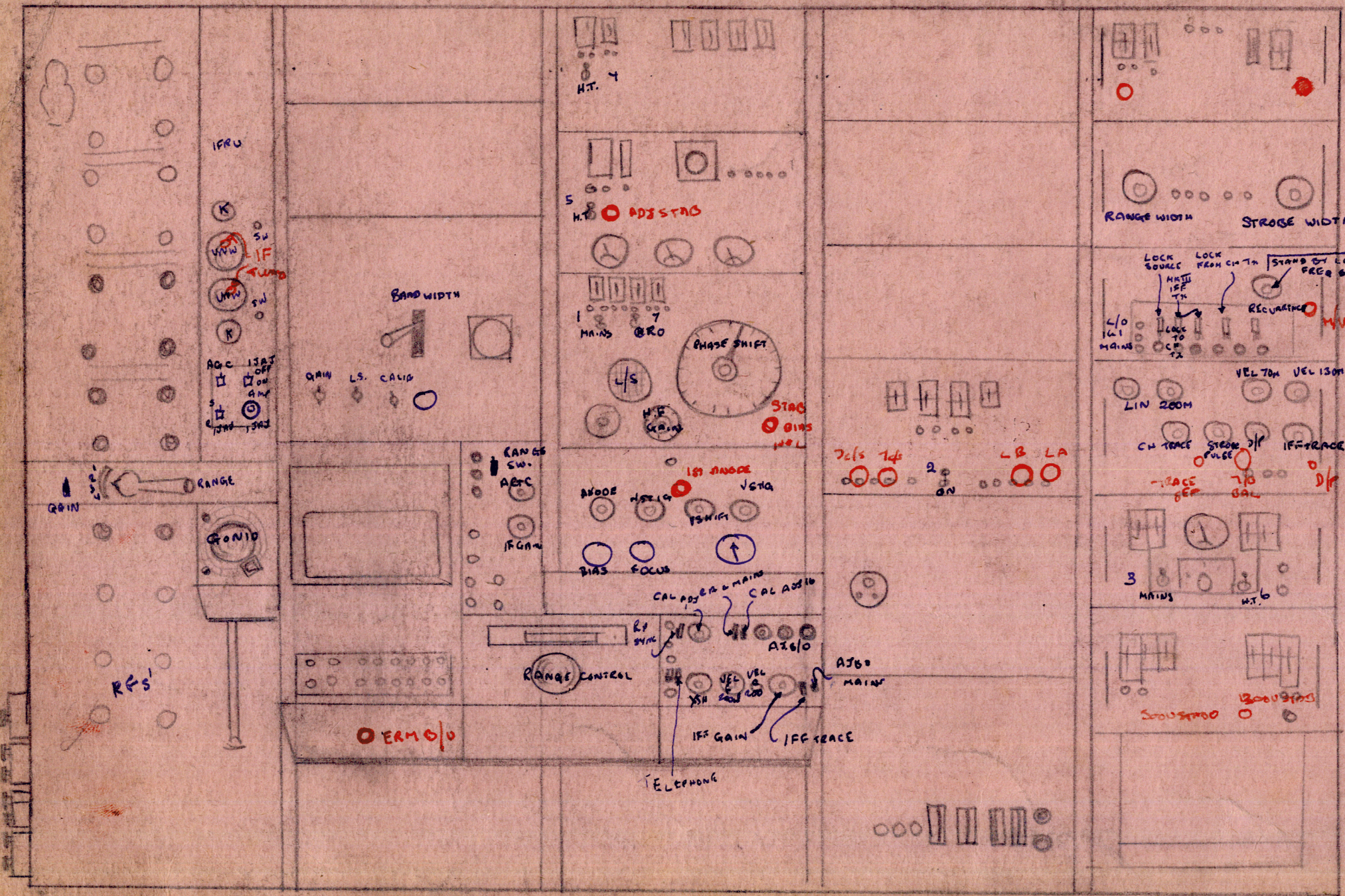

0-Res



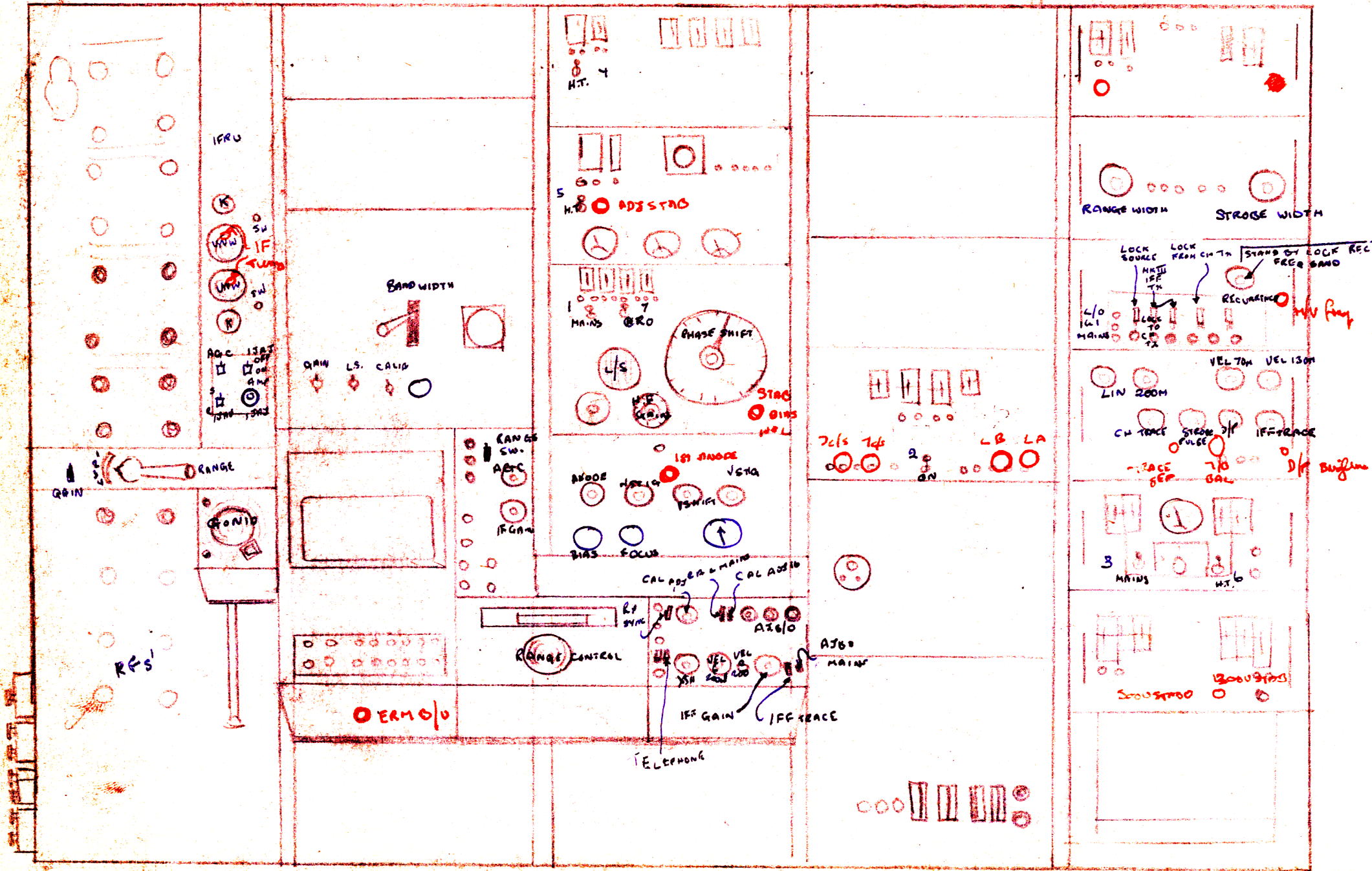

O - Res



Meters Reading  
Cylinder Gauge

1.3104

General Details:

The Tx frequency (it has two push button frequency changes). Frequencies are in two ranges:-

- 1) 20-33 Mc/s
- 2) 30-50 Mc/s

Power Output is up to a maximum of 400KW. Square wave output

PRF Three possible, 50, 25 & 12.5 pulses/sec.

Pulse widths " " 5 Uses, 171 Uses, 3074 Uses

Modulator Vb. V 1301

Values

Push Pull Master Oscillator 2 CV1058 triodes in push full (some use VT.98)

Class 'C' push full tetrode amp. 2 VT114's in push full. These feed the aerial

A



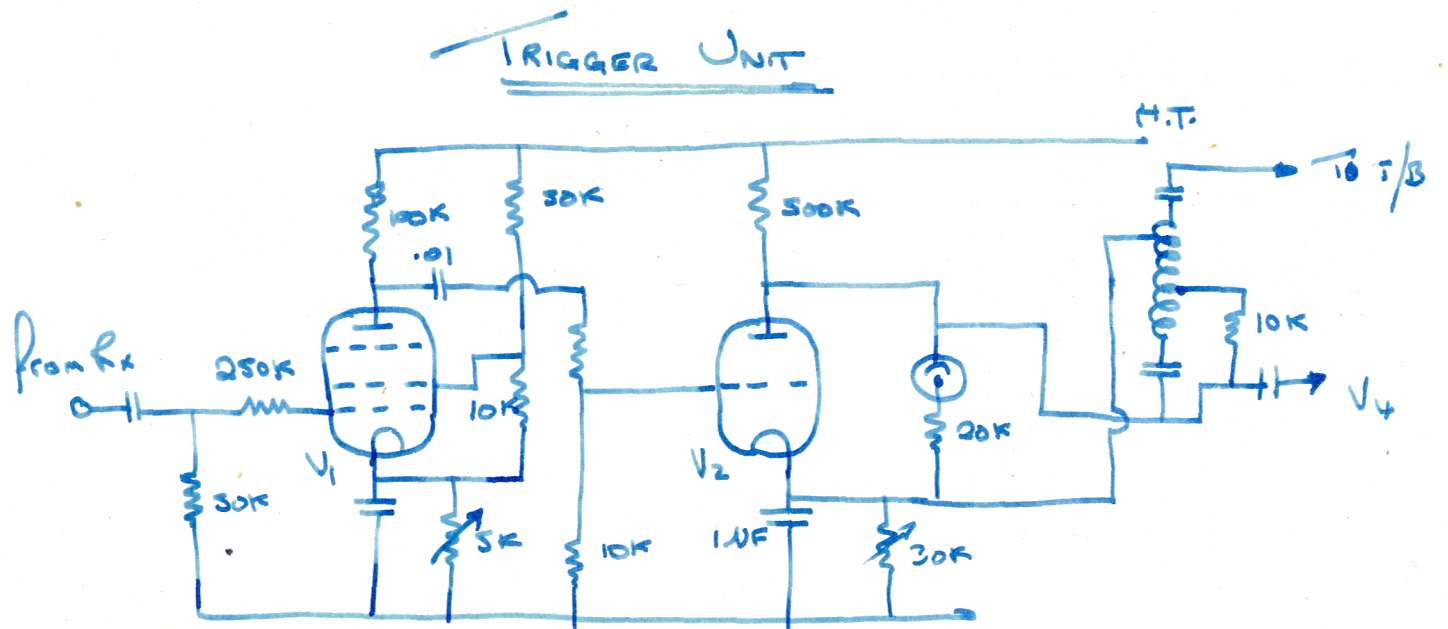
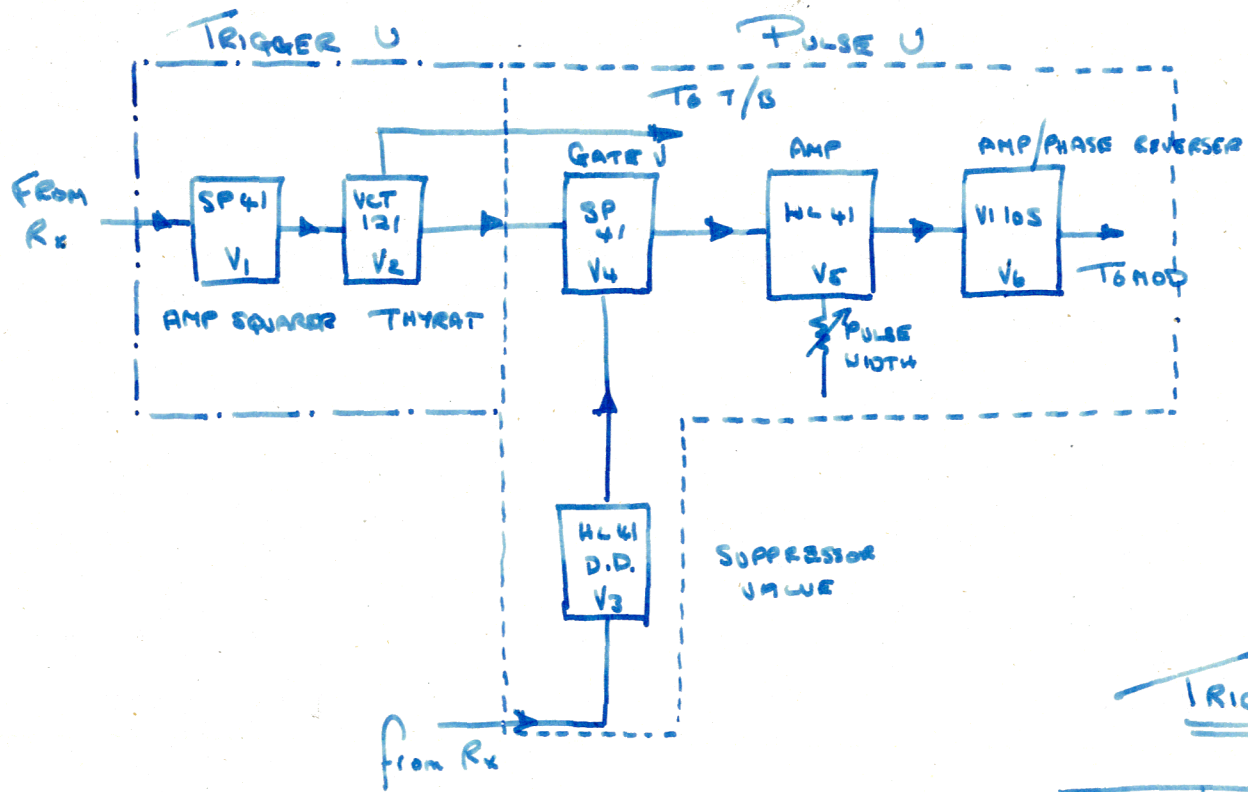



# Block Diagram

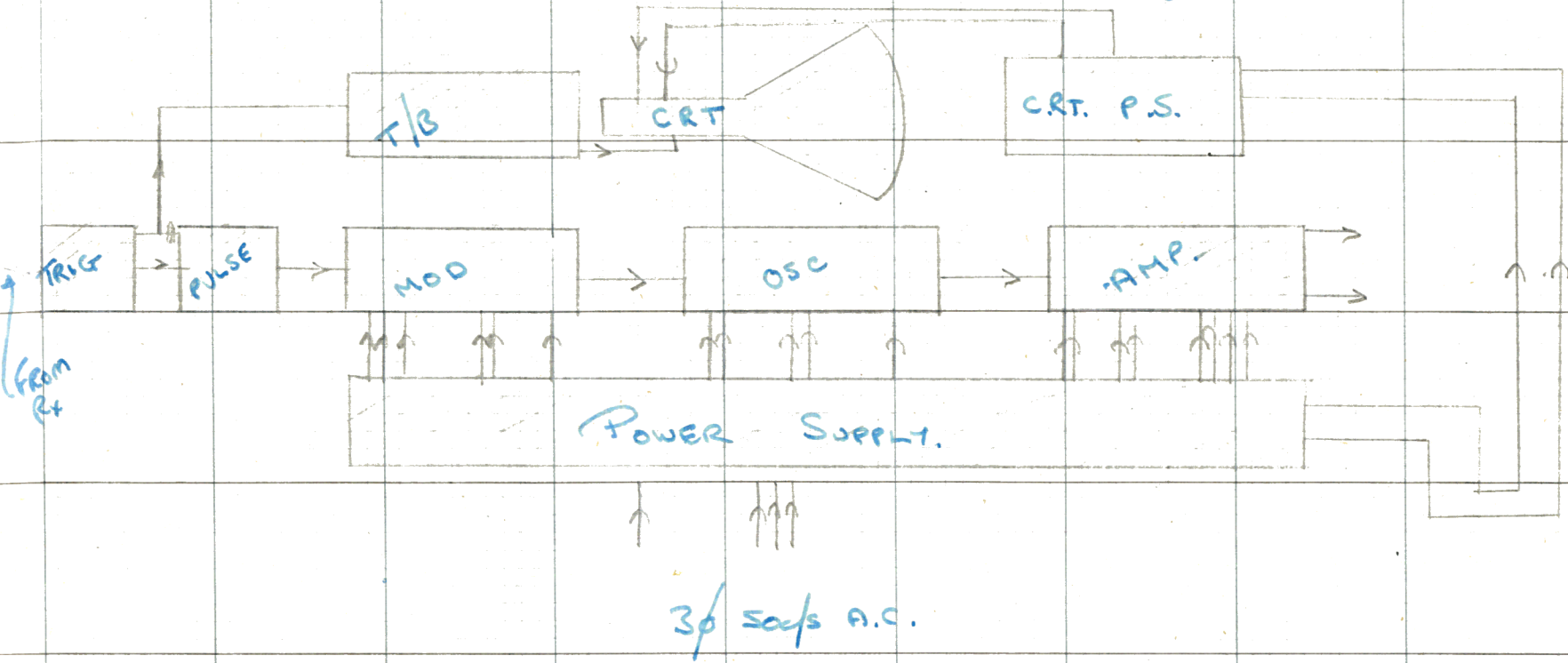



## Operation of Trigger Circuit

The square wave looking signal 25c/s supplied by the receiver is applied through the 250K resistor to the grid of  $V_1$ .  $V_1$  is biased by anode current through the 5K resistor and steady current for the H.T. line through 10K and 5K resistors. If the square wave on the grid of  $V_1$  has steeping sides the striking instant of  $V_2$  is governed by position of 5K variable which forms the "Phase Lock" control.

Anode circuit of  $V_1$  is completed by 100K resistor. Output of w/f from  $V_1$  is differentiated by S.T.C. 0.1uF. 250K + 10K. Anode of Thyatron connected to  $V_4$  by .02 + .01 uF condensers.

### Operation of $V_2$

$V_2$  is non conducting between pulses being missed by voltage across 30K var. resistor. When large pulse arrives on the grid, the thyatron strikes and two things happen:-

- 1) The neon is extinguished and
- 2) The circuit consisting of the bottom half of the inductance, and the .02 condenser is caused to oscillate at its resonant frequency. As the thyatron is included

in the circuit & can only conduct in one direction only one half wave of oscillation takes place the resultant half wave of voltage across the inductance consists of a -ve half wave followed by a +ve half wave at its junction of the .02 and .01 condensers. This +ve half wave of voltage provides the pulse which is fed to the grid of  $V_4$  through the .01 uF.

At the upper end of the inductance a voltage wave is produced consisting of a +ve half wave followed by a -ve one. This w/f is fed through the .001 to provide triggering for the time base.

The T/S is triggered by the +ve crest therefore the T/S will commence 150° before the transmitter pulse is produced.



## PULSE UNIT

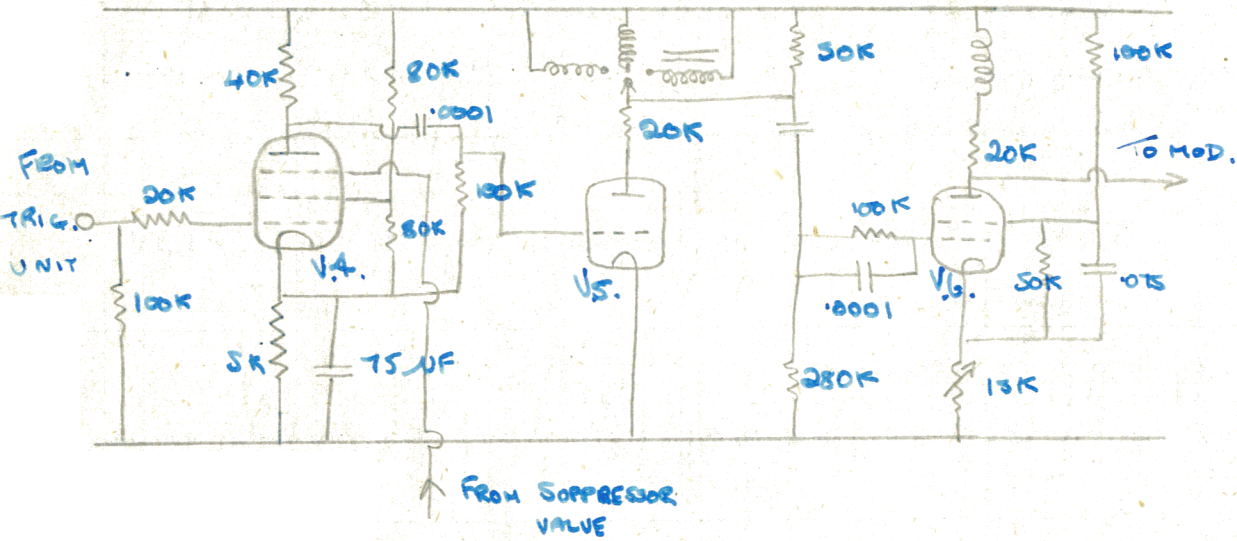

### Operation

The +ve pulse from the trigger unit is fed through the 20K resistor to the control grid of  $V_4$ . The main use of  $V_4$  is to provide a gate valve whereby each alternate pulse may be cut off for  $2\frac{1}{2}$  c/s working.

The -ve pulses from  $V_4$  anode are passed to the grid of  $V_5$  through the  $.0001 \mu F$  condenser.

$V_5$  is provided to enable the pulse width to be adjusted

by means of three switched chokes in the anode circuit. The chokes can be remotely selected by means of relays built into the pulse unit.

The +ve u/f from  $V_5$  anode is passed via the pulse shaping network  $.5 \mu F$ ,  $100K$ ,  $.0001 \mu F$  &  $250K$  to the grid of  $V_6$ . The variable bias on grid of  $V_6$  goes beyond cut off by the variable resistor (5K) which forms the "WIDTH TRIM CONTROL". Variation of this bias adjusts the point at which anode current flows, and gives fine control of pulse width.

In the anode circuit of  $V_6$  is a choke, providing a large overvoltage at the beginning of the pulse to cause the R.F. oscillations to build up rapidly at the beginning of the R.F. pulse.



T 3104 Suppressor.

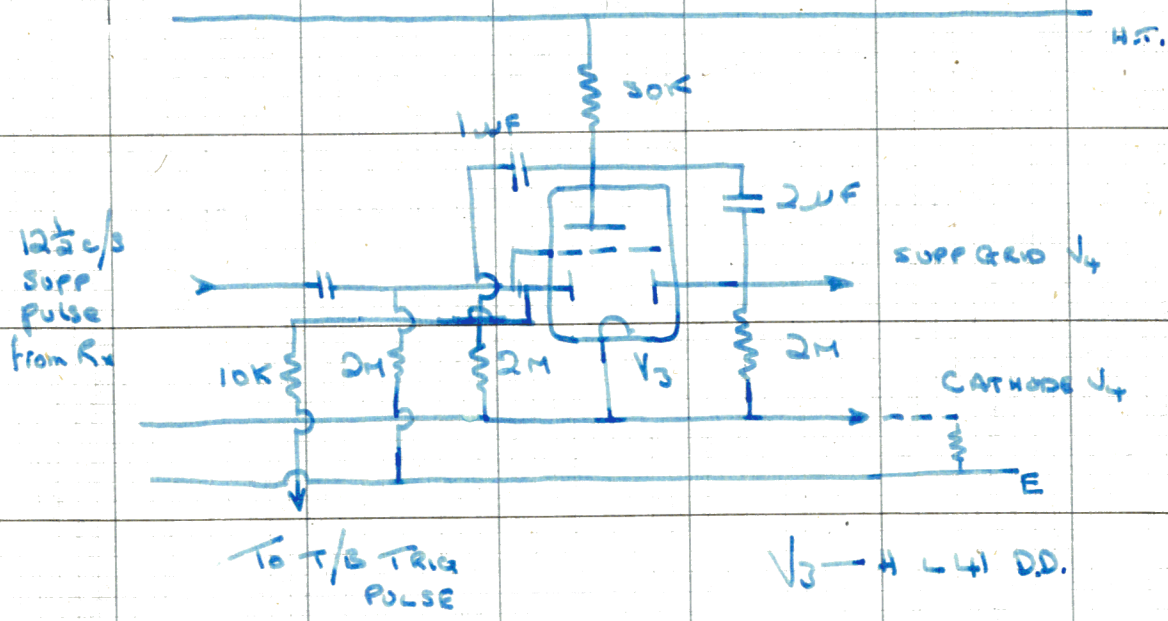

Operation

When the  $12\frac{1}{2}$  c/s suppressor pulse is applied from the received through the  $1\mu F$  condenser to the grid of  $V_3$  -ve going pulses are provided at the anode which are applied through the  $2\mu F$  condenser to the suppressor grid of  $V_4$ . These cut off each alternate  $25$  c/s locking pulse. The suppressor grid of  $V_4$  is also connected by means of a  $2M\Omega$  resistor to its cathode. This resistor is shunted by one of the diodes in  $V_3$  which -vely D.C. restores the supp pulse at  $V_4$  supp. grid. The -ve pulses at  $V_3$  anode are also applied to the remaining diode of  $V_3$ . This diode anode is connected through a  $2M\Omega$  resistor to the cathode of  $V_4$ , and through a  $10K$  resistor to the T/B triggering source. In this way each alternate T/B triggering pulse is suppressed causing the T/B to trigger only  $12\frac{1}{2}$  times per second.



# MODULATOR

# VALVE

## CIRCUIT

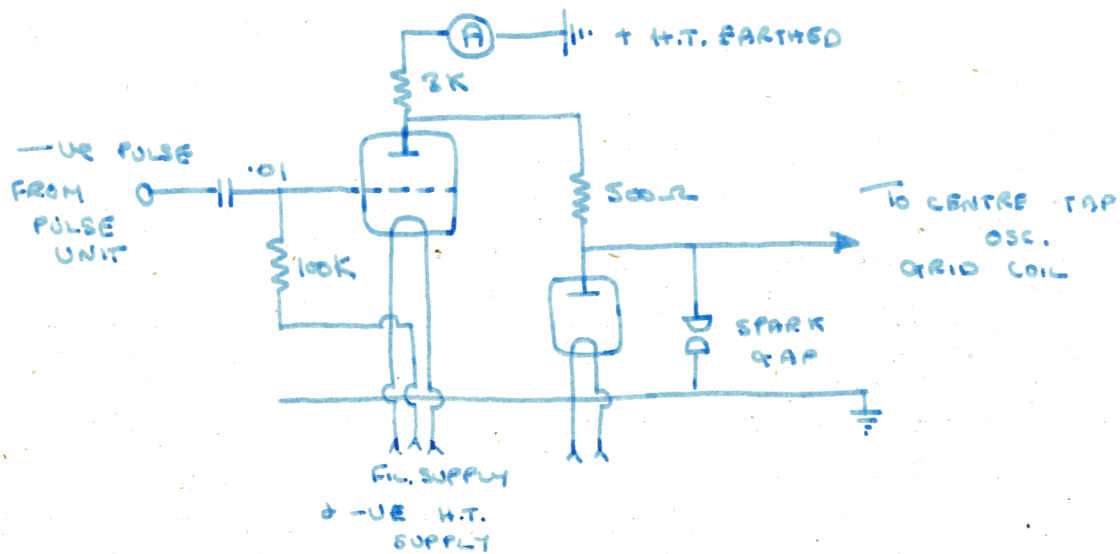

## Operation

The triode modulator valve is normally conducting due to its grid being at the same potential as the cathode. The heavy current being passed by the valve causes a voltage of approx 1500 volts to be dropped across its 3K anode load.

As the +ve supply side of the H.T. supply is earthed the anode of the modulator will be -ve with

respect to earth. The centre tap of the oscillator grid coil is connected to the mod. valve anode via the 500 ohm resistor and is held at -1500 volts while the valve is conducting. When the -ve pulse arrives on the mod valve grid, the valve is cut off resulting in the sudden reduction of bias on the oscillator and the commencement of R.F. oscillation. A safety spark gap is provided between the osc grids and earth to avoid damage to the mod valve and its anode load in the event of flashover between osc grid valves grid and anode. The diode across the spark gap prevents secondary emission and the osc. grids going +ve during the pulse period.

# T 3104 Waveforms

## MODULATOR LAYOUT

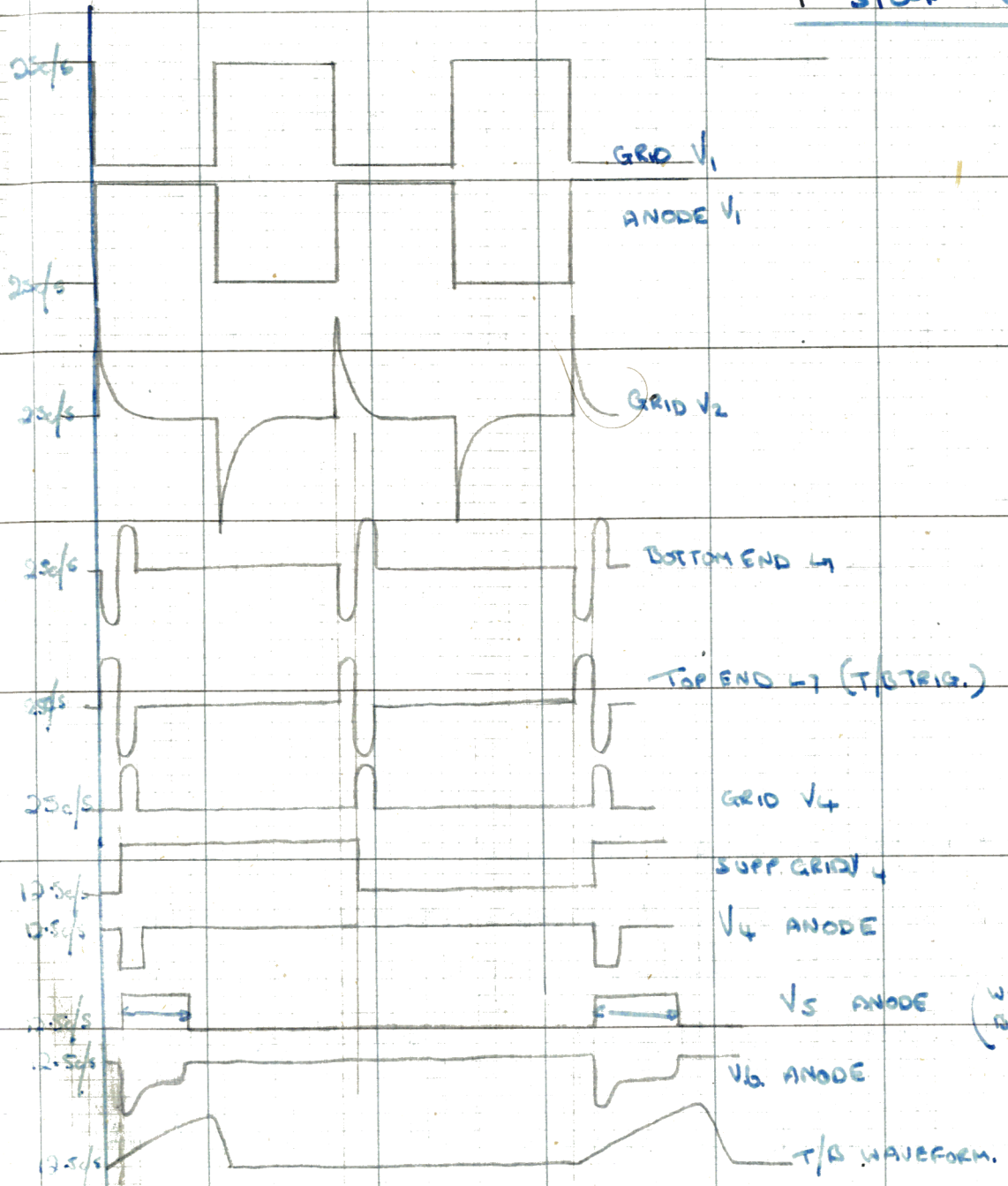

WIDTH CONTROLLED BY CHORE IN CIRCUIT.

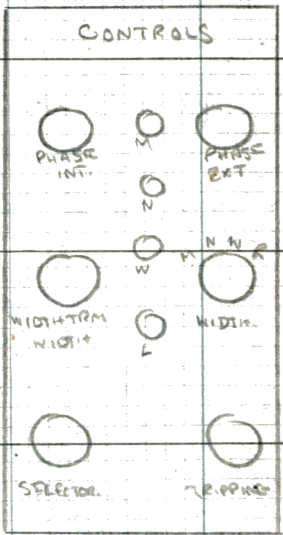
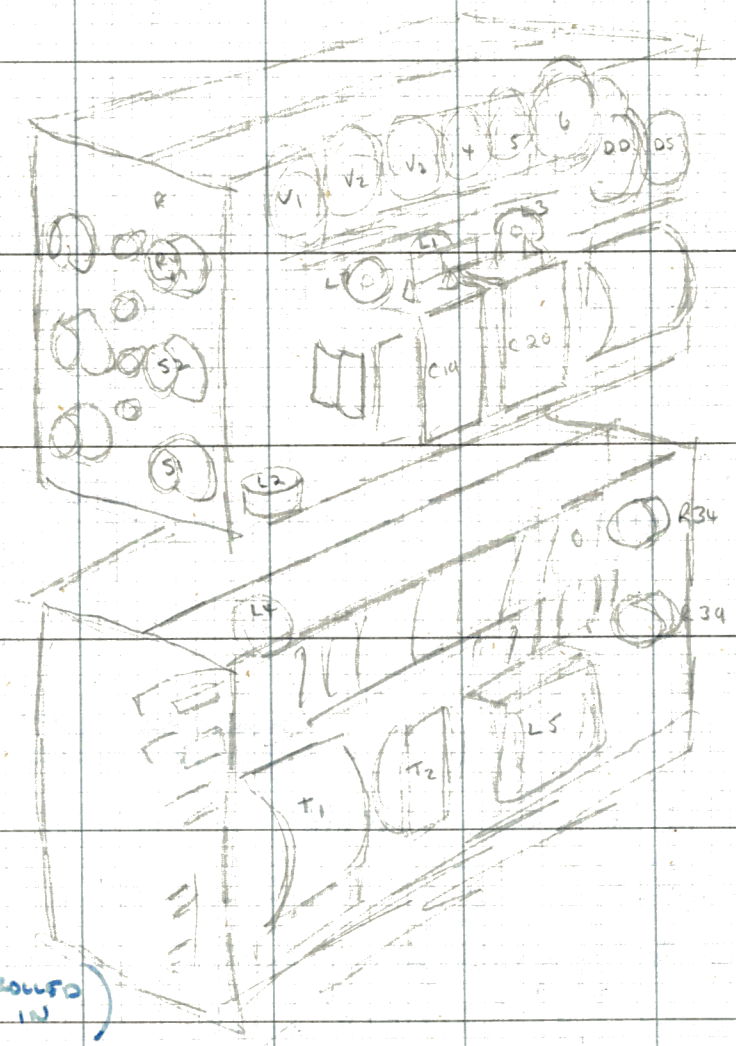



## INTERNAL LOCKING

The grid of  $V_3$  is excited through the Wfd. condenser  $C_8$ , and  $V_1$  grid is connected to the secondary winding of  $T_2$ , which provides the 50c/s voltage of approx. 50 volts amplitude which is squared by  $V_1$  due to the driving of  $V_1$  into grid current and the cutoff of anode current on the -ve half cycle. The phase of the 50c/s voltage is varied by a phase shifting network in the tuning ckt. of  $T_2$ .

In the thyatron cathode circuit a switch adjusts the time constant of the biasing circuit, to permit the thyatron to conduct on either

- ① Each +ve pulse on its grid.
- ② Every second pulse on its grid
- or ③ Every fourth pulse.

From  $V_4$  onwards, all the circuits fulfill the same function as on external locking.

## MONITOR CRT T/B.

The thyatron, which is normally cut off, is caused to conduct by the arrival on its grid of the +ve triggering pulse from trigger unit. The .02 and .01 discharge through top half of coil L. Voltage developed in this half reproduced in lower half, due to magnetic coupling. X plates are connected to coil ends. The discharge time of .02 & .01 is varied by 25K variable resistor — "TIME SWEEP" control. Thyatron then extinguished by large drop in anode voltage across high resistance in its anode load ckt.

Bright up valve, normally conducting, cut off when its grid goes negative due to voltage at its upper half of coil L +ve pulse produced at anode which is fed to grid of C.R.T. This +ve pulse removes the large black out bias normally

MONITOR CRT T/B.

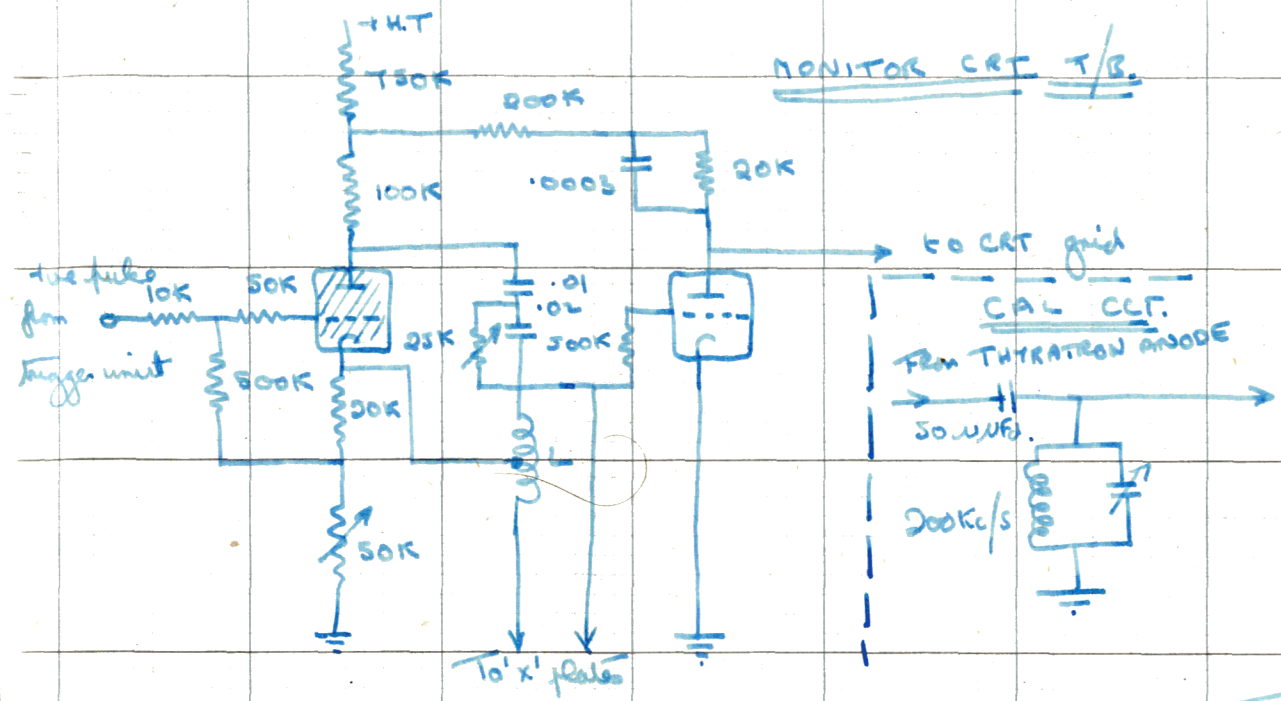

applied to the grid on the forward stroke of the T/B.

Calibration of the T/B is carried out by means of a tuned ckt. resonant at 200 Kc/s which is caused to ring by sudden drop in voltage at the thyatron anode, which is coupled to the tuned ckt. by a 50μF d. As the freq. of tuned ckt. is 200 Kc/s, the interval of time between consecutive +ve waves will be 5 μsec.

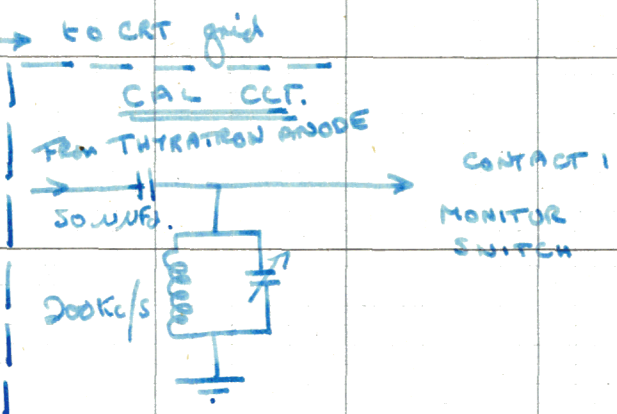

H.T. supplies

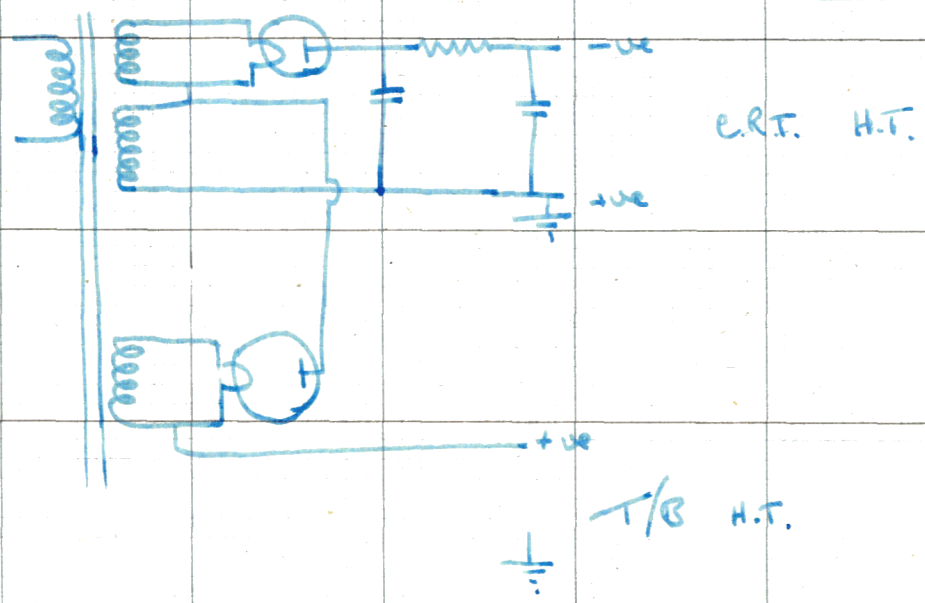

CRT tube circuit is conventional and ~~has~~ needs no description  
 Power supplies.

The power supply for both T/B and CRT is derived from a power supply on T/B chassis  
 One H.T. winding on the x former supplies both +ve ~~anode~~ H.T. for T/B and -ve HT for CRT by the use of two separate reco.



1/3 UNIT LAYOUT

RIGHT HAND  
SIDE

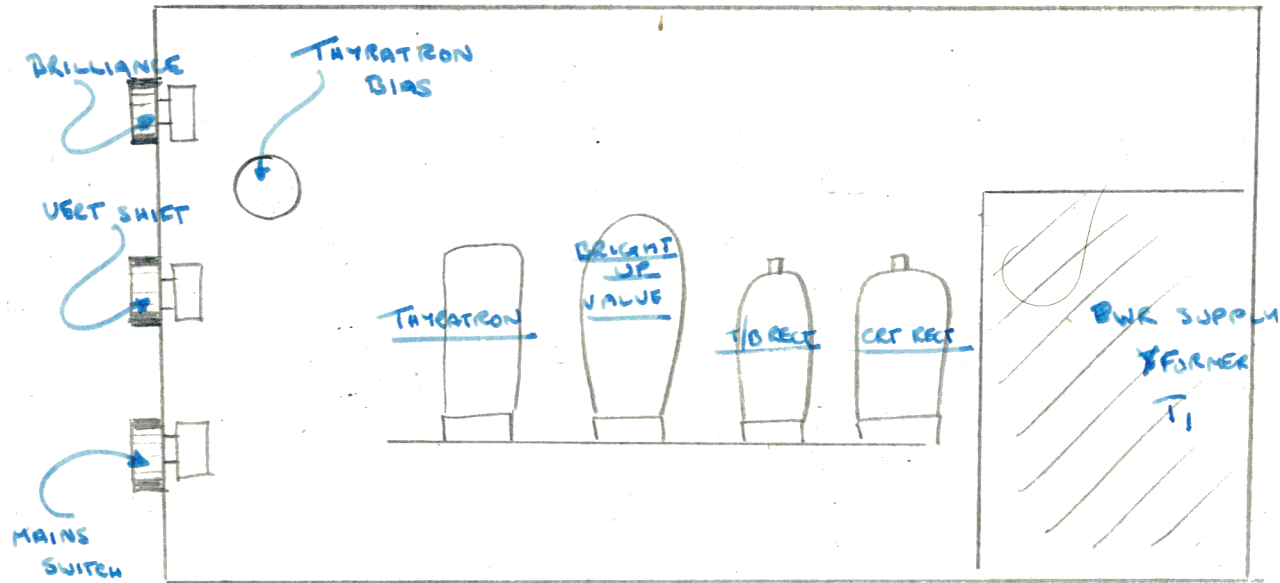

LEFT HAND  
SIDE

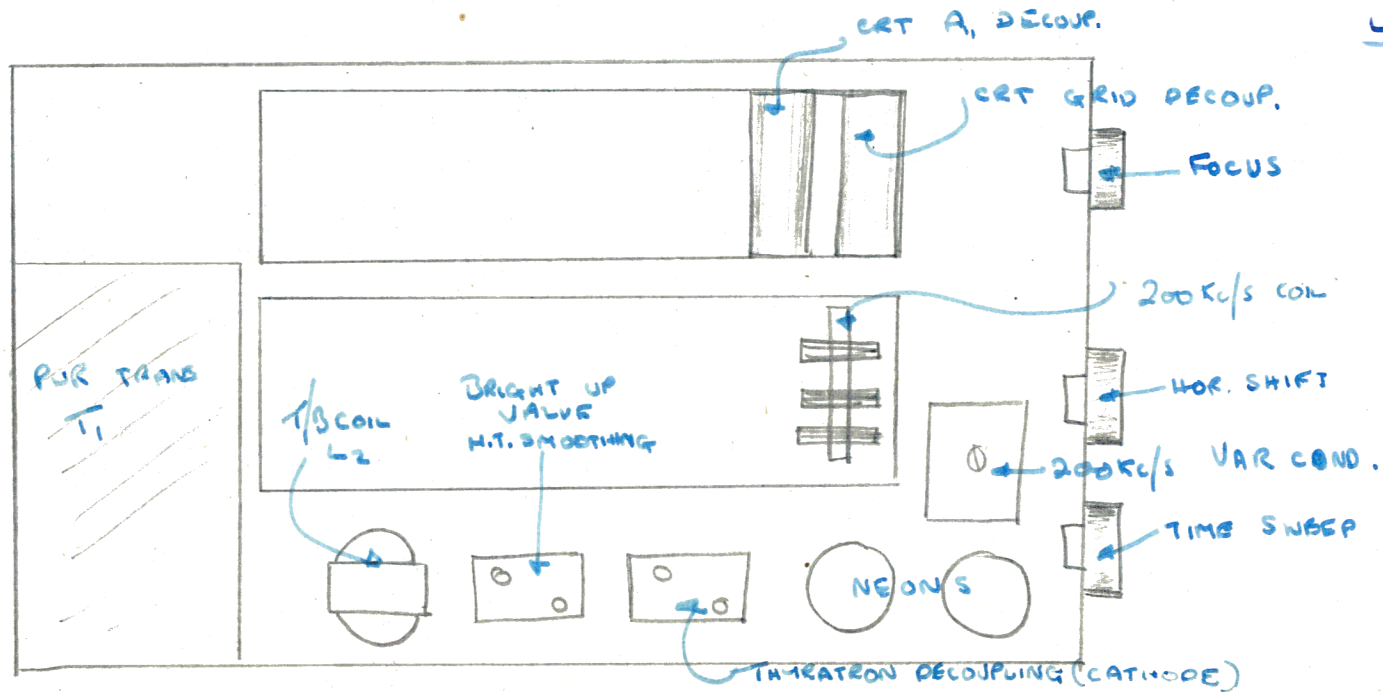

RF CIRCUITS.

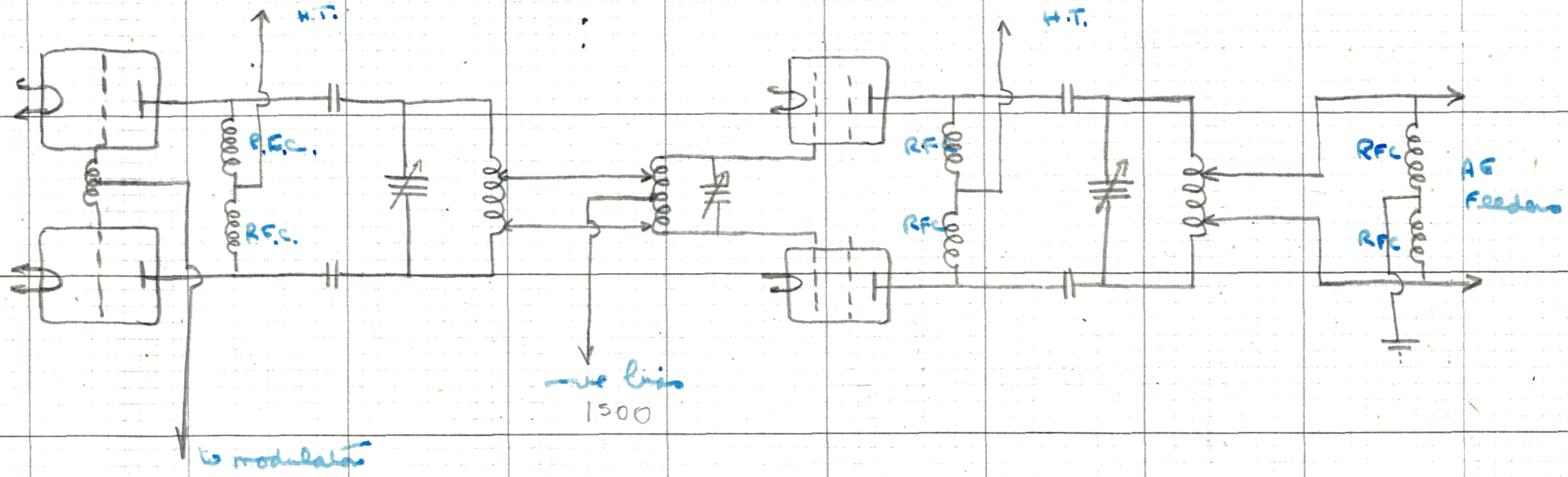

to modulator

OSC

AMP

The oscillator stage consists of two VT 580 or VT 980 in a P.P. T.A.T.G. osc. Alternating anode and grid circuits may be selected by a push button controlled wavechange system. The tuning of the oscillator grid circuit is done by tapping on the coil the centre of which goes to mod. valve anode. The osc. anode ckt. is tuned by last tapping on the coil, and split stator condenser. The wave change ckt. is shunt fed from the anodes by R.F. chokes and coupling condensers.

The PA stage comprises two VT 114's in P.P. Coupling from osc stage to grid is by means of a short length of twin feeder tapped across a small section of the respective coil at each end. The PA. grid ckt. is tuned by tapping on the coil and a split stator condenser. The PA. anode ckt. is tuned by tapping on the coil and in some transmitters by a split stator condenser. Alternating coils are provided in the PA circuit for wave changing in the same manner as the osc. circuit. The o/p to the aerials is taken from



tappings on the shunt fed model coil, across the aerial feeders are connected two R.F. chokes in series with the centre point earthed. This arrangement results in a balanced output to match the aerial feeders. Change over of the aerial feeders is accomplished by wavechange system.

AERIAL SYSTEM.

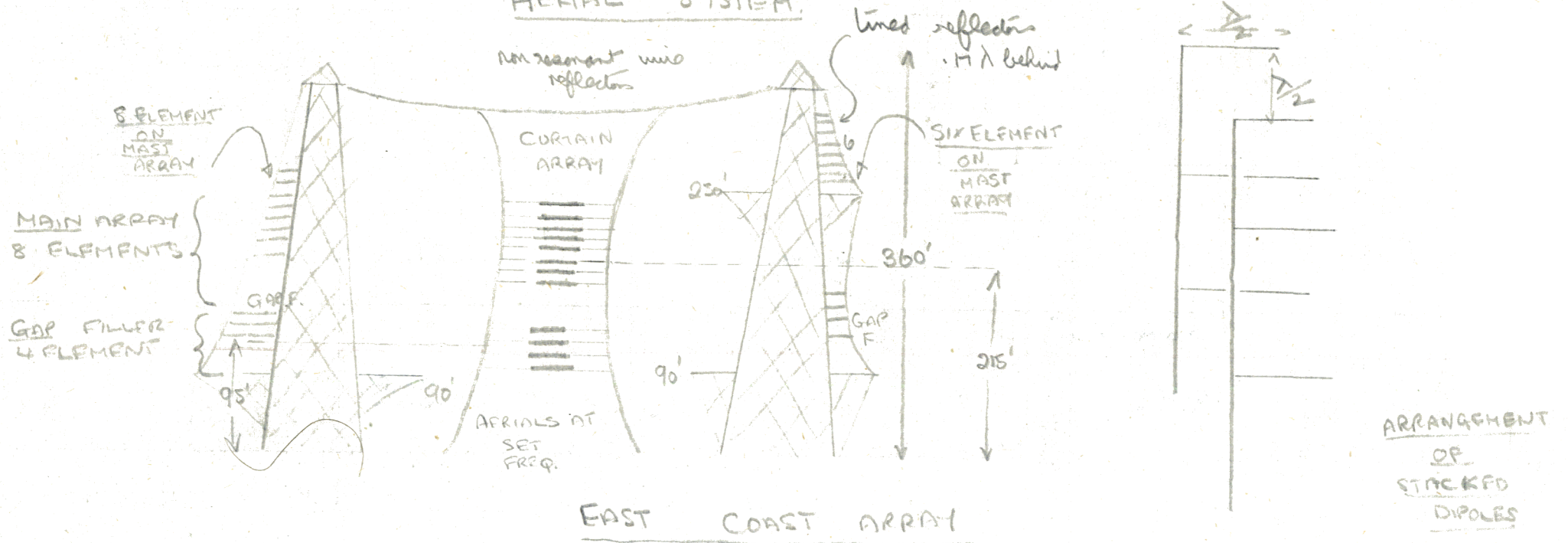

Mast stations use a combination of a curtain array and one of the mast systems

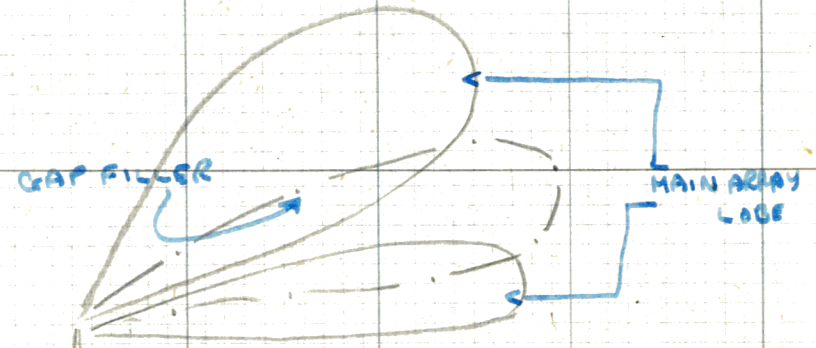
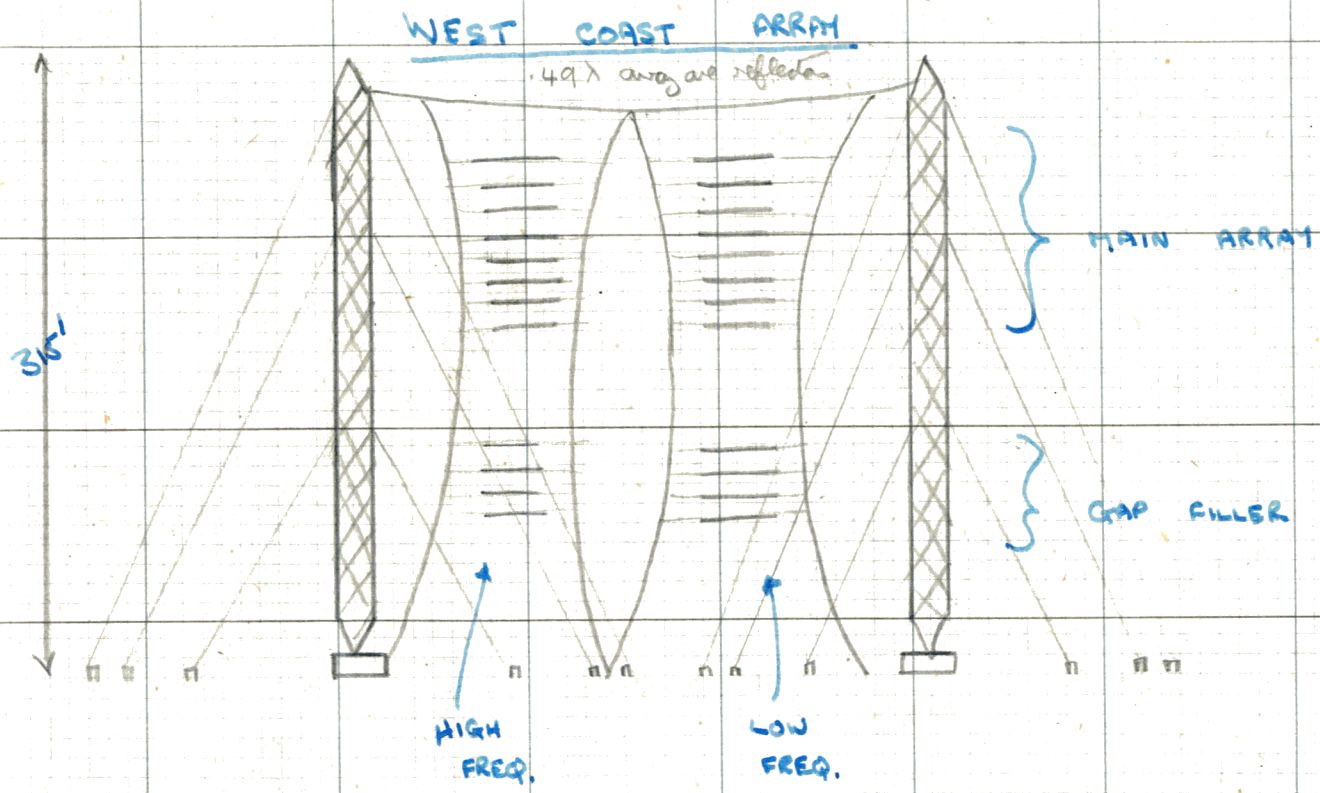

VERTICAL POLAR DIAGRAM.

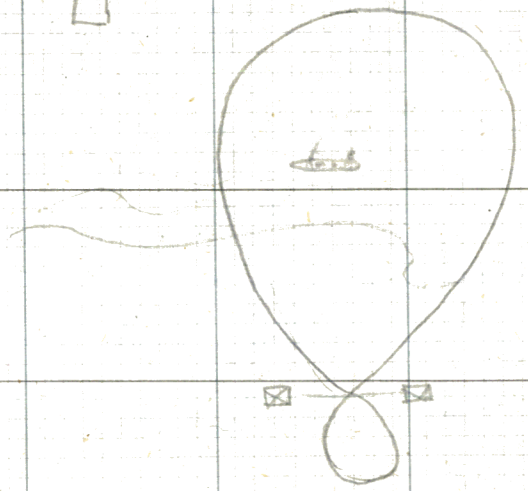

HORIZONTAL POLAR DIAGRAM

Contractor System

1) Isolator switch in position "B" — A.C. is applied to Fan 1, 115 primary, main voltmeter and is available for the control circuits



- 2) Fan 1 tilt switch and "Fil Aux" isolator switch set up circuit for switching on filaments
- 3) "Fil on" button is pressed energising O/C<sub>1</sub> contactor<sub>1</sub> closes and completes mains supply for mains transformer "Aux" contacts bridge "Fil On" button and T.D<sub>1</sub> is started
- 4) T.D<sub>1</sub> closes energising O/C<sub>2</sub>, contactor 2 closes, completing Fan 2 circuit; shunting R<sub>13</sub> & part of R<sub>12</sub>, and R<sub>11</sub> & part of R<sub>10</sub>, and starting T.D<sub>2</sub>  
Fan 2 tilt switch partially completes circuit of O/C<sub>3</sub>
- 5) T.D<sub>2</sub> closes and energises O/C<sub>3</sub>. Contactor 3 closes starting remainder of R<sub>12</sub> and R<sub>10</sub> (and so apply full voltage to files) and starting fan 3, & T.D<sub>3</sub>. Fan 3 tilt switch partially completes circuit of "Fil On" lamp
- 6) T.D<sub>3</sub> closes, completing "Fil On" lamp circuit and, when isolator switch is put in position "C" setting up circuit for O/C<sub>4</sub>.
- 7) "Mod On" button is pressed, energising O/C<sub>4</sub>  
Aux<sub>4</sub> contacts bridge "Mod on" button, contactor 4 closes switching on AC to lines supply transformer setting up circuit for screen H.T. trans. completing AC supply to mod. H.T. trans and R<sub>43</sub> in series (series with mod H.T. & fona) and starting SUNVIC relay V.D<sub>2</sub>
- 8) V.D<sub>2</sub> closes, starting R<sub>43</sub>, and so applying full H.T. to mod valve and setting up circuit for O/C<sub>5</sub>
- 9) H.T. on button is pressed, completing O/C<sub>5</sub> circuit, contactor<sub>5</sub> closes applying AC, through R<sub>35</sub>, to H.T. auto-transformer, and starting V.D<sub>1</sub>. When V.D<sub>1</sub> closes starting R<sub>35</sub>, full H.T. is applied to oscillator valves, and "ac. HT" lamp lights to full brilliance.
- 10) H.T. is applied to amplifier when isolator switch is in position "D".

# POWER UNIT LAYOUTS

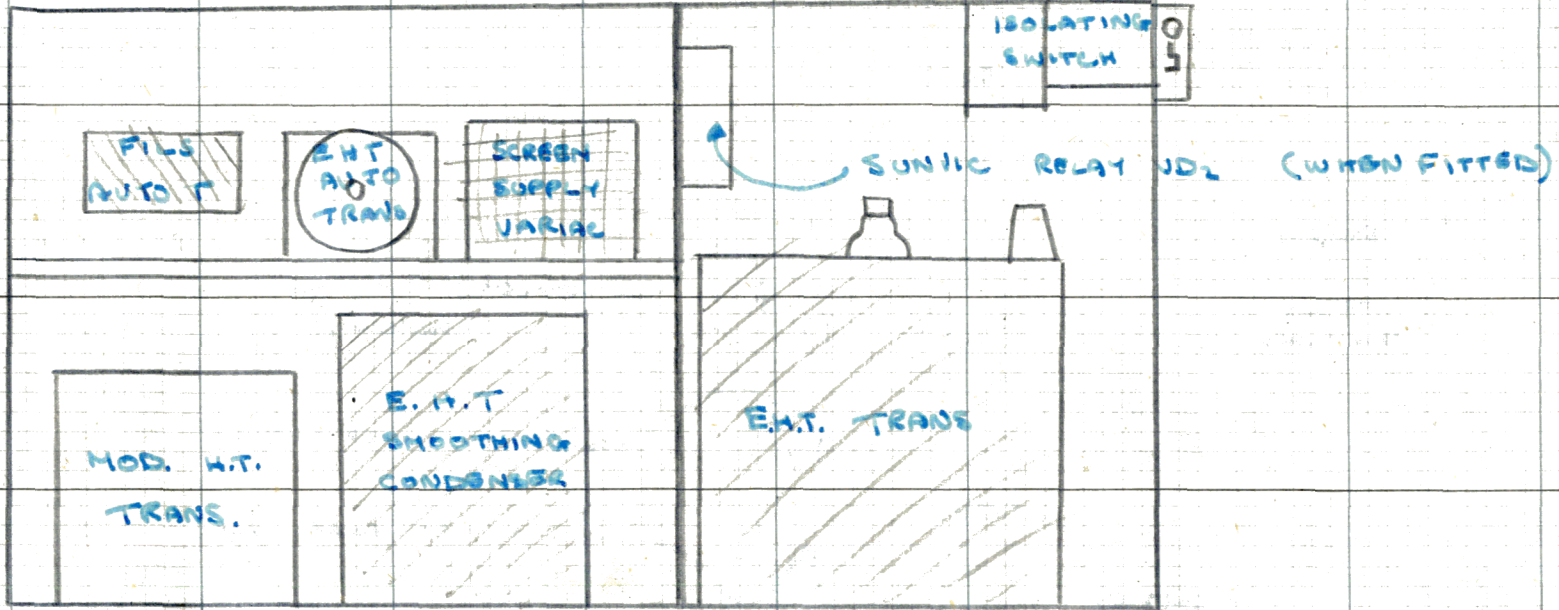

LOWER COMPARTMENTS FRONT REAR

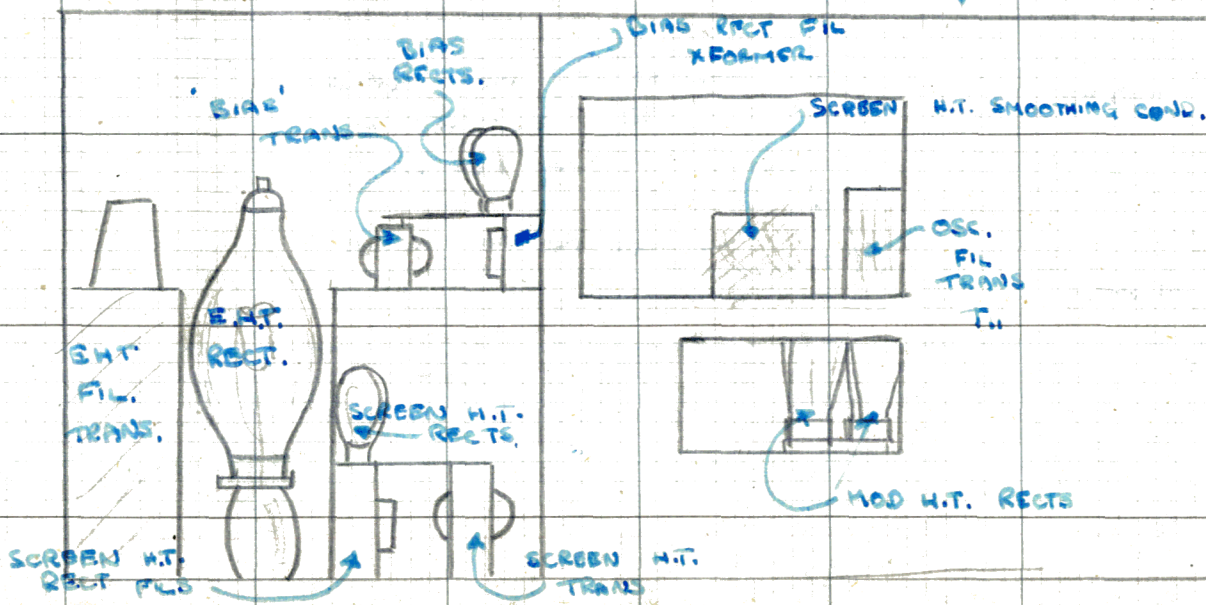



# CONTACTOR SYSTEM

3 $\phi$  AC IN

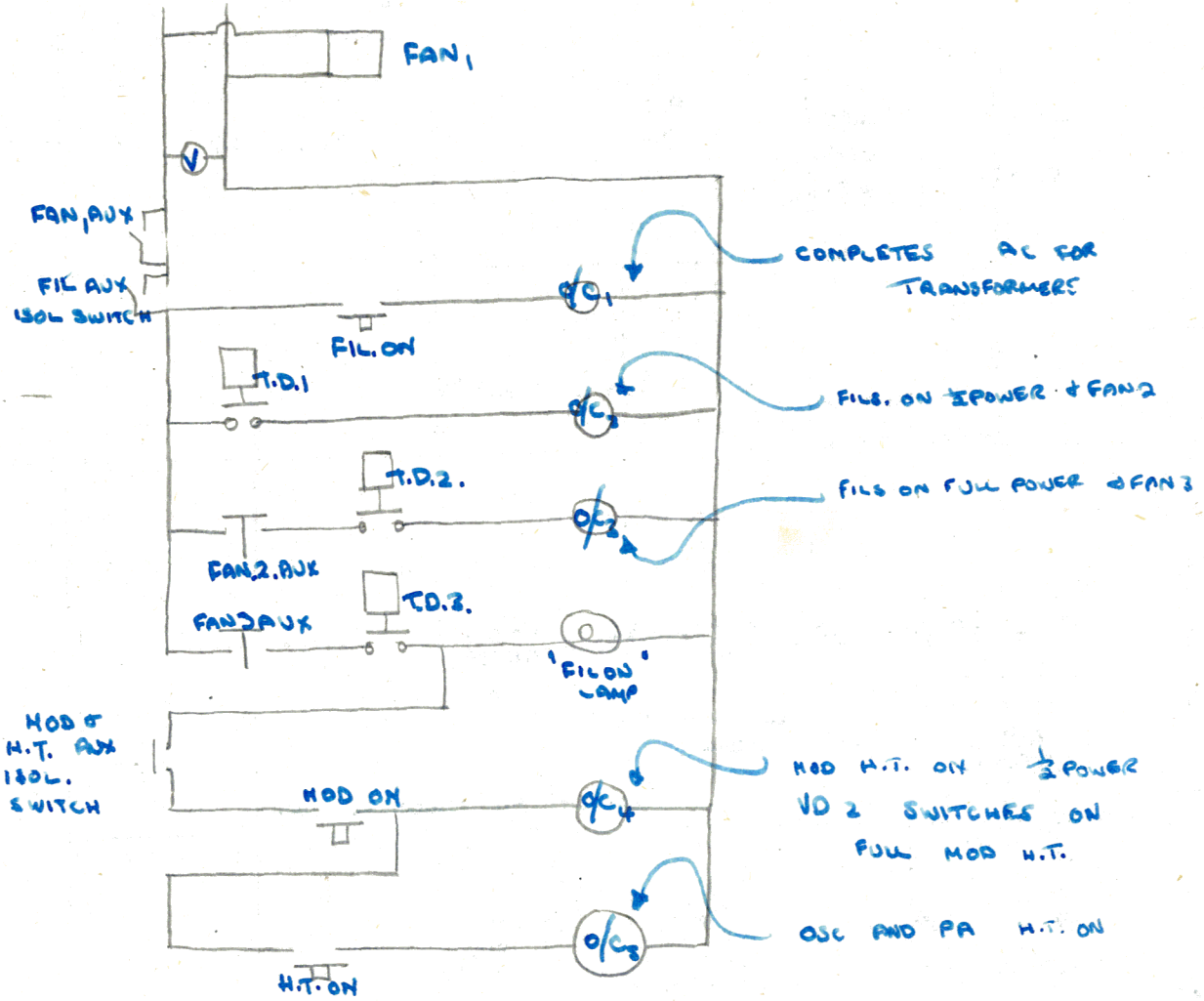
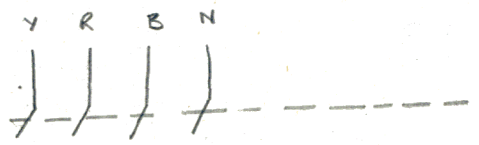

## Function of Cooling System

- Fan 1: Cools Amplifier and Oscillator components
- Fan 2: Modulator and T/B
- Fan 3: Power Supply units



### Measurement of Power Output

is done, as in G, by means of rheostat and lamps. The rheostat is scaled.

### Wavechange Operation

The wavechange motor control circuit is fed through fuses L-T. 240V AC for the operation of the wavechange lamps and C.R.R. is derived from T15

When PB is pressed, C.R.R. is energized and its contacts disconnect O/S (switching off main H.T.) and energize the wavechange motor which operates the V.C. switches and the drum switches, which start the PB, and connect 12V supply to the appropriate lamp.

## Wavechange System

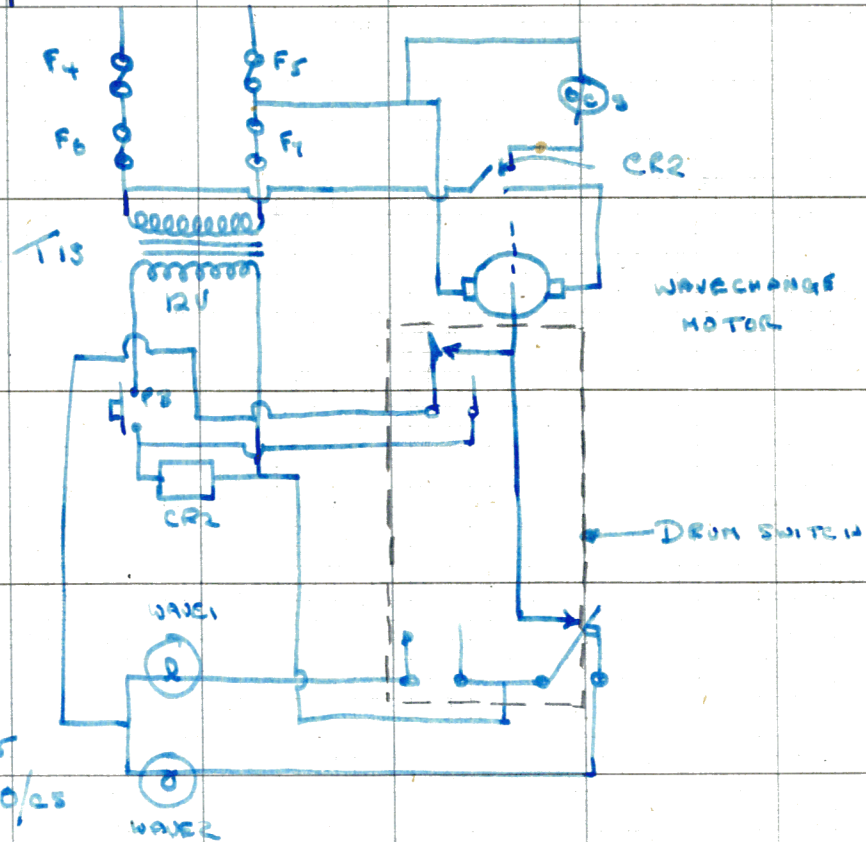



Running Up  
Wavechange System

PLAN VIEW OF WAVECHANGE MECHANISM.

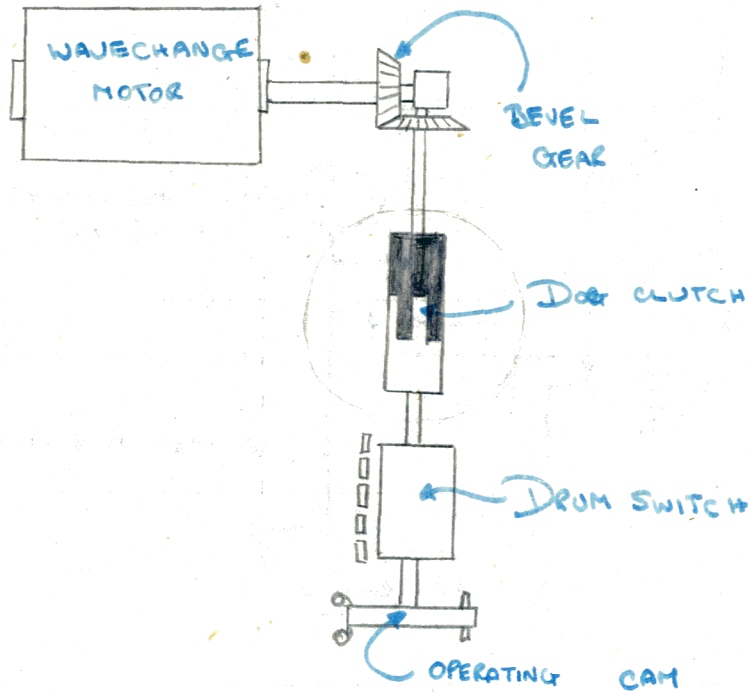

OPERATING CAM END VIEW

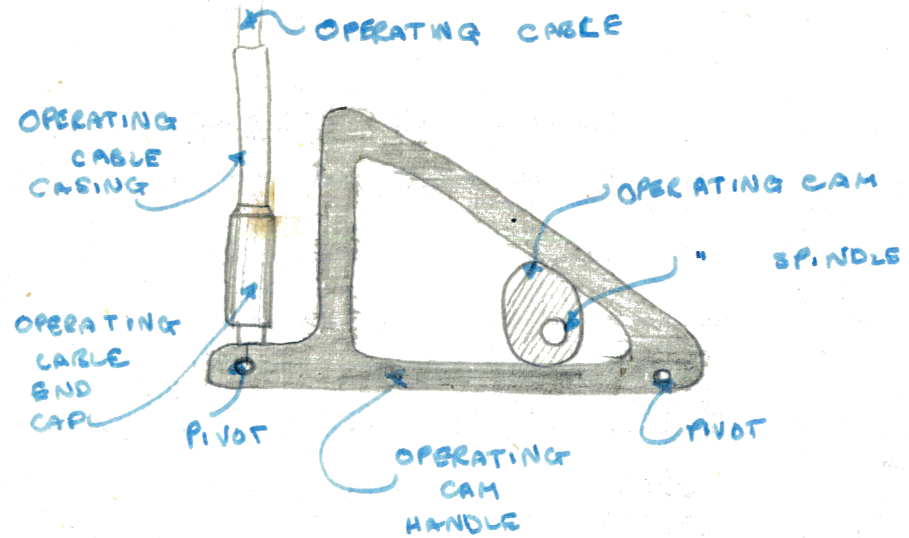

SECTION OF OPERATING CABLE

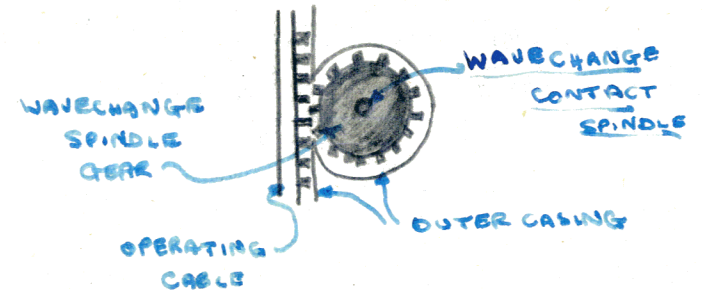
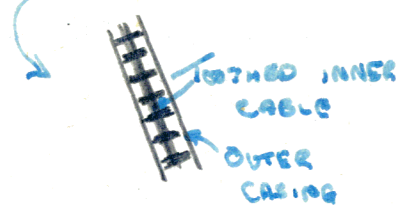

SECTION OF SANDOPE OPERATING GEAR

## WAVECHANGE MECHANISM (CONT.)

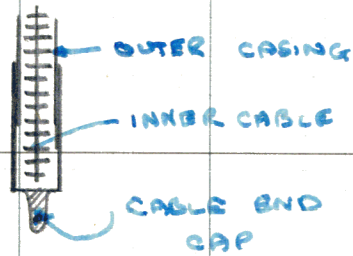

END CAP IS SLIDING FIT ON OUTER CASING

## Running Up. T 3104.

1) Put isolator switch into position A

2) Press "Fil On" button (this supplies power to fil. and pulse and trigger units) T/A and CRT can switched on by switch on Modulator unit. Wait until all are running. Filaments and wave lamps should now be alight. Check filament volts and adjust if necessary. Put isolator switch in position D. Press mod on button and check mod value current - this should be approx. 5amps. Adjust CRT to get a clear trace on tube. Put waveform selector switch on trigger and pulse unit to position T. Waveform on CRT should be approx:—



Check amplifier G.B. it should be approx 1-1.2 K. Press main H.T. push button and turn screen grid voltage control to approx. 1KV. Main H.T. control to stud 6 or 7 trace on CRT should now be approx:—

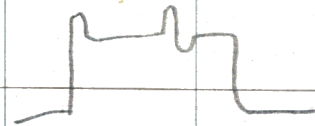

If all correct turn screen and H.T. controls to maximum position and trace on tube should now be:—  
Maximum permissible readings on meters should now be:—

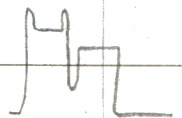



osc anode current — 2 mA  
amp. anode " — 13 mA  
amp. screen current — 1 mA  
" grid " — between 2 & 4 mA  
No main H.T. wattmeter.

AMES TYPE 1

R.3016A

General Data

a) Sometimes known as R.F.8 [Rack 23 included]

b) Range  
i) 20 Mc/s  
ii) 130 Mc/s.  
iii) 70 Mc/s

c) Freq. range  
20-60 Mc/s

Bandwidths

i) 20-30 Mc/s [in use at present]  
ii) 26-38 Mc/s  
iii) 32-50 Mc/s  
iv) 40-60 Mc/s

R. 3016A      SETTING ) UP    INSTRUCTIONS.

Running Up.

1. Switch "ON" at the supply source.
2. Switch "ON" mains on P12, ACC4 and mains on P21.
3. After approx. 30 secs. switch on H.T. switches on P11 & P10.
4. Switch on H.T. switches on P. 21 and CRO switch on P12.
5. Adjust anode control on HT4 for a voltmeter reading of 5.5 - 6 KV after allowing approx. 30 secs for "warming up".
6. Adjust BIAS control for visible trace.

Running Down.

1. Turn BIAS control fully anti-clockwise.
2. Switch off in following order.
  - a) CRO on P12 panel.
  - b) HT    " P21    "
  - c) HT    " P10 & P11 panels.
  - d) MAINS on P21 panel.
  - e) ACC4 panel.
  - f) MAINS on P12 panel.
  - g) Break MAINS input at source.

B/U CHAIN

1. Switch on Rx as detailed in "Running Up" procedure.
2. Switch on MAINS and HT on console.
3. Switch on CAL MAINS on CP10H.
4. Put Rx SYNC SELECTOR switch to CAL position.
5. Select 200M time-base with range switch (CP10F)
6. Turn all brightener controls (T13) fully anti-clockwise.
7. Adjust BIAS control until the time-base and spots at its commencement just disappear.
8. Turn CH trace brightener until time-base re-appears at desired brilliancy.
9. Set Rx SYNC SELECTOR switch to NORMAL, and IFF trace switch to ON (CP10H).
10. Set IFF switch (LK1) to NOT IN USE position.
11. Adjust IFF trace brightener (T13) until IFF trace is barely visible.
12. Adjust STROBE & DP brighteners for visible pulses, after ensuring that DP control on console is set to display the DP on a 200M time-base.
13. Check that adjustments are correct for 130M & 70M time-bases.

ERM.

1. Switch on CAL MAINS and select CAL sync. (CH10).
2. Ensure that at least 16 cal. markers are displayed. If necessary adjust RANGE WIDTH control on R1 panel.
3. Set ERM range control (CP10G) to the red 1 mark on the range drum.
4. By means of CAL ADJUST 1 control (CP10H) move range marker to cover first visible cal. marker.
5. Set ERM range control to red 16 mark on the range drum.
6. By means of CAL ADJUST 16 switch, move range marker to cover 16th cal marker.
7. Re-check adjustment as in para 5.

N.B. THE "CAL ADJUST 16 SWITCH MUST BE OPERATED FOR BRIEF PERIODS ONLY.



R3010A - LAYOUT OF PANELS

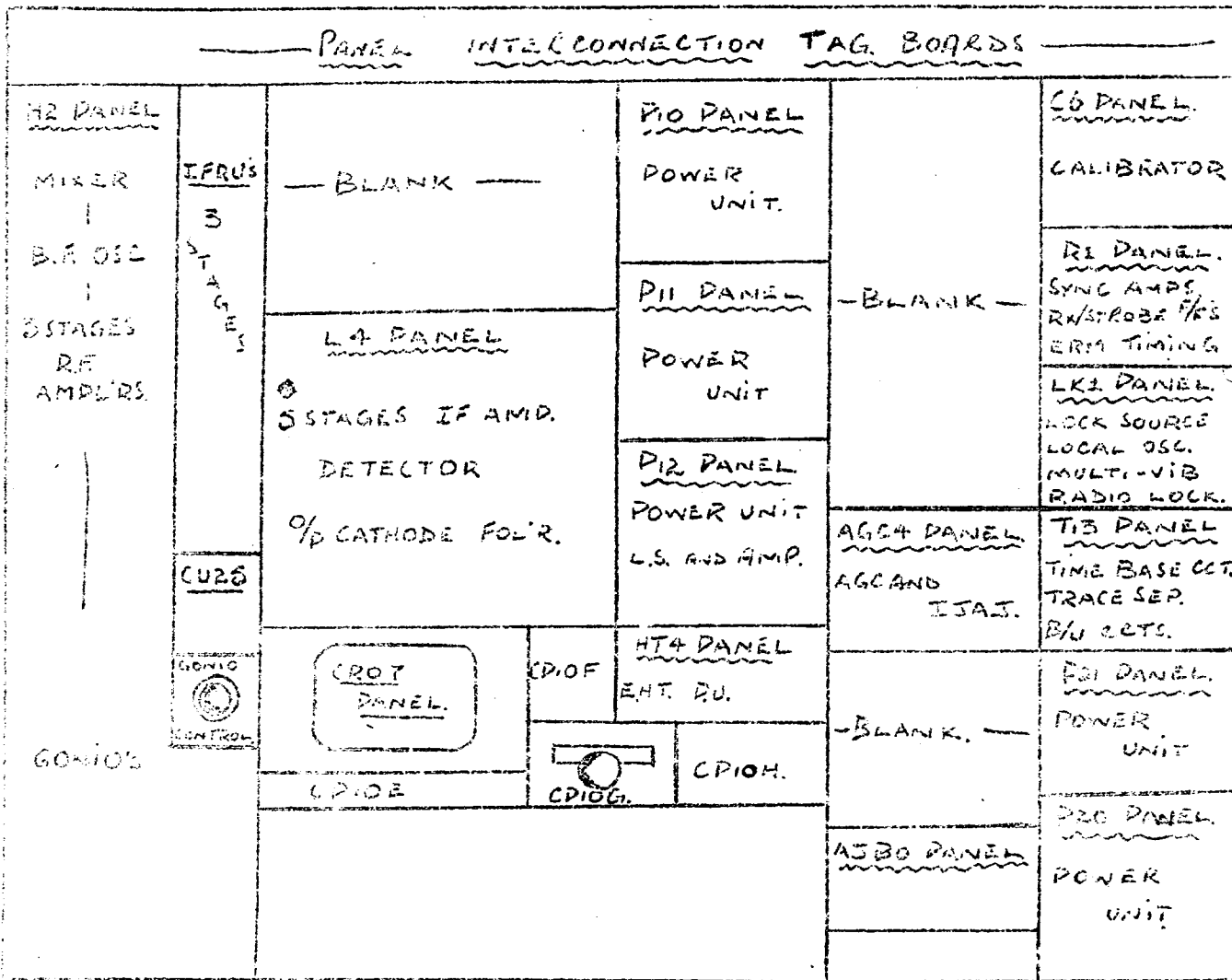

AMES TYPE 1

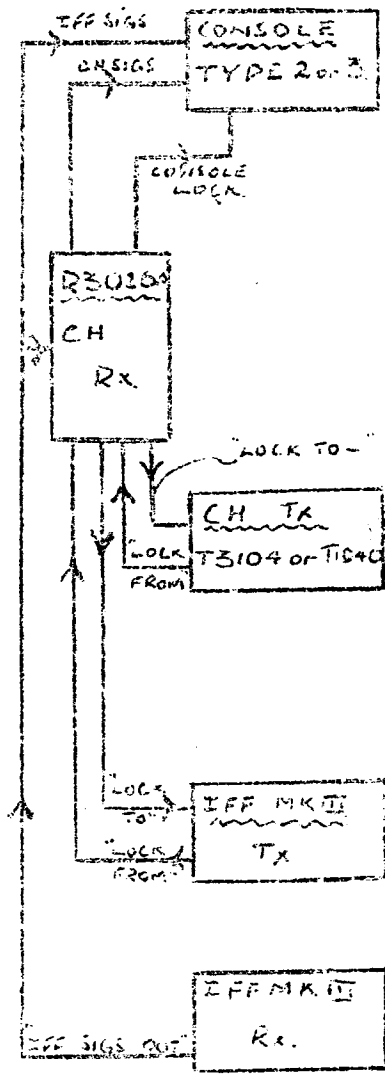

GENERAL PLAN OF TYPICAL STATION

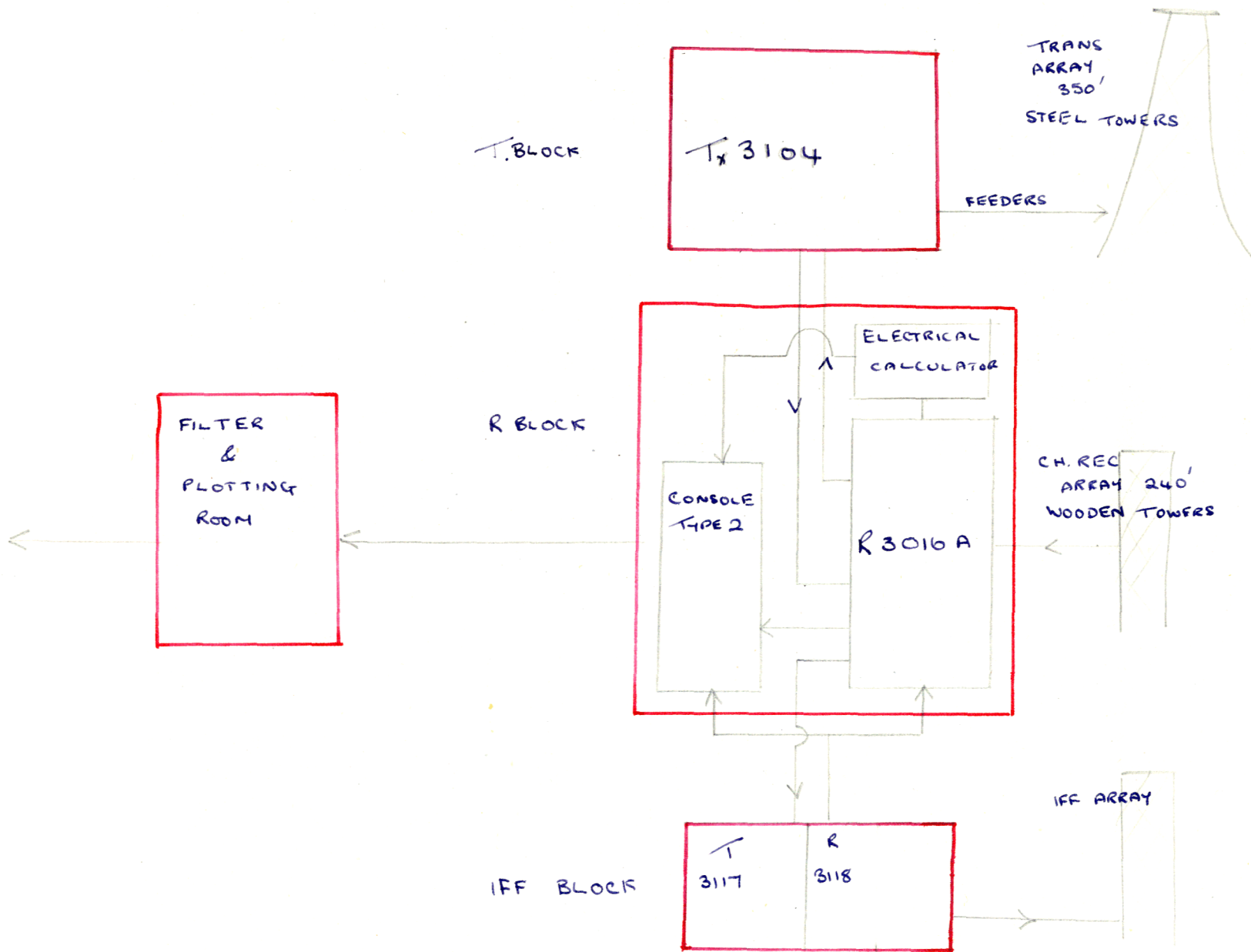



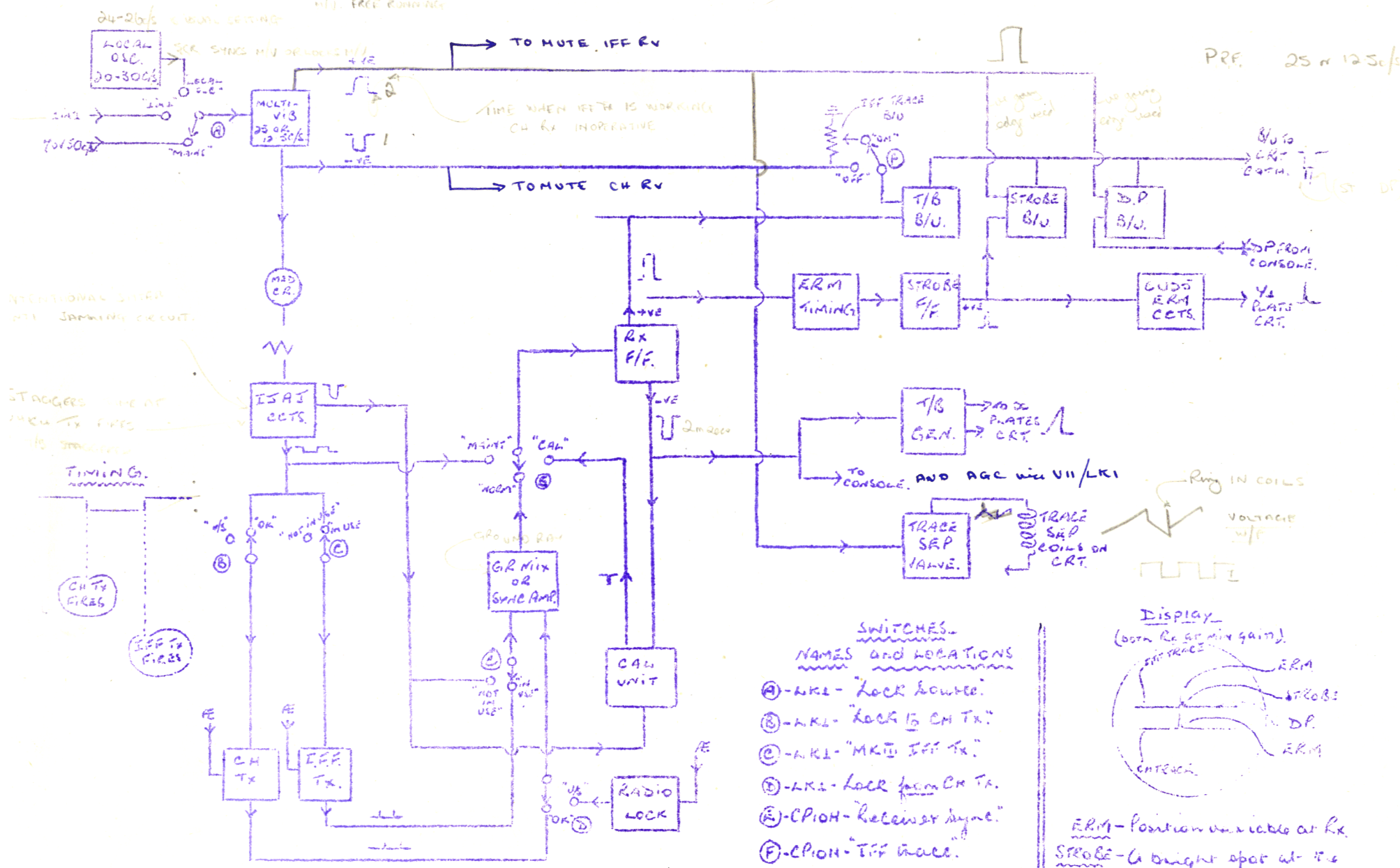

RB016 - SIMPLIFIED BLOCK CIRCUIT

Display  
(both Rx & mix gain).

ERM - Position variable at Rx

STROBE - A bright spot at the foot of the ERM on the IFF trace only.

D.P. - A bright spot on the IFF trace, its position varied from the console.

# LK1 PANEL

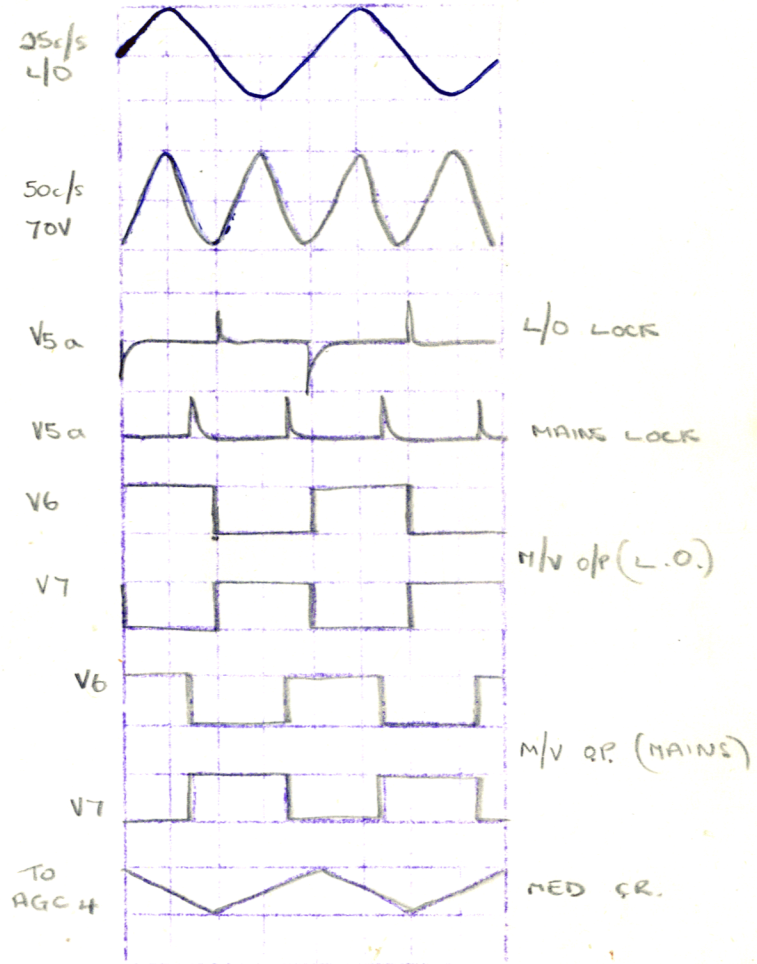
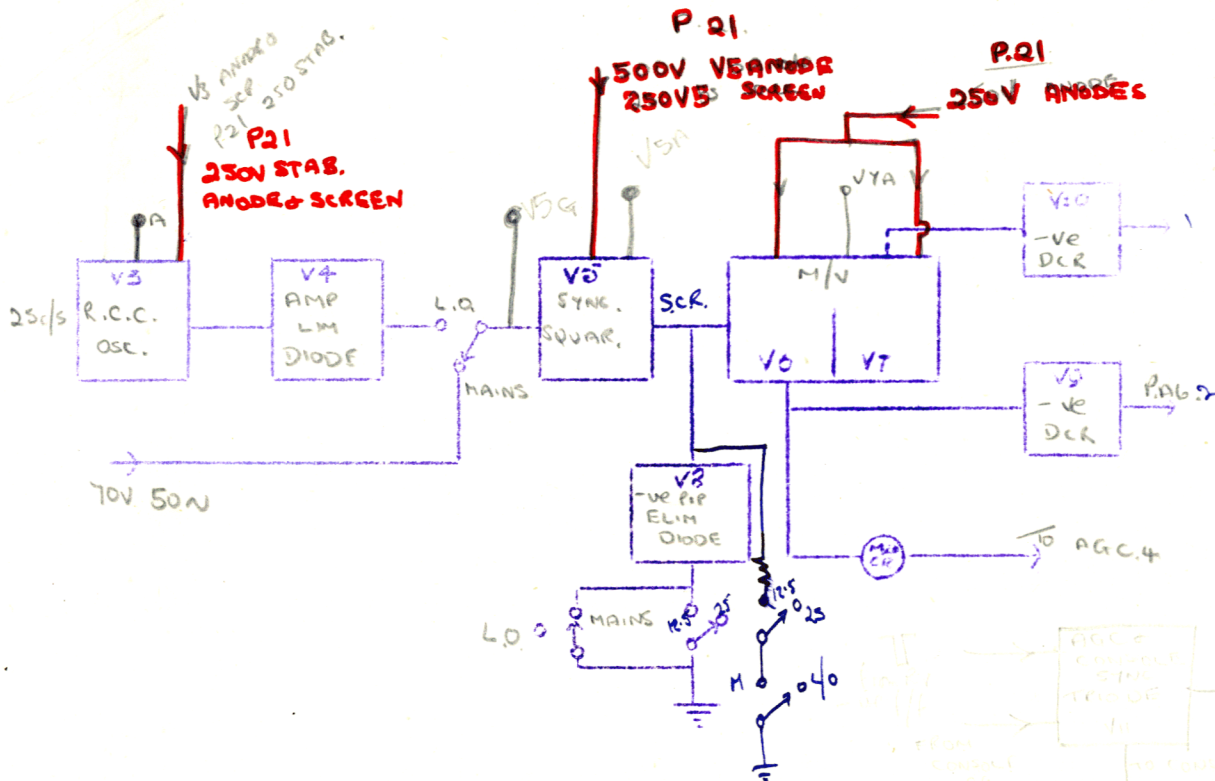
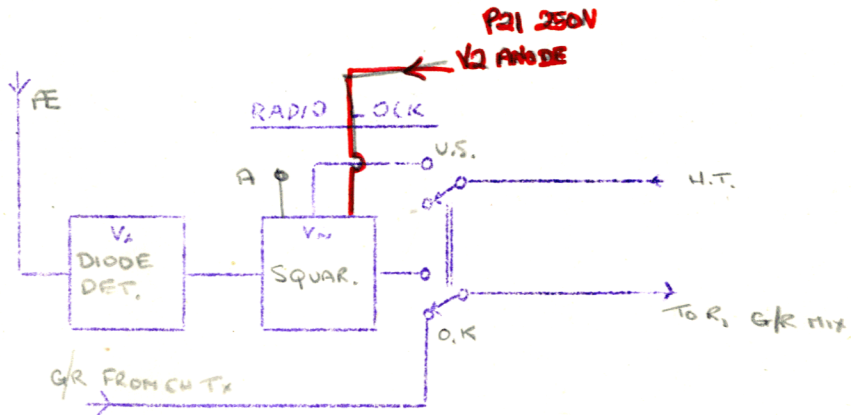

V11  
AGC SYNC  
P21 250V ANODE

WAVEFORMS

LOCK 1

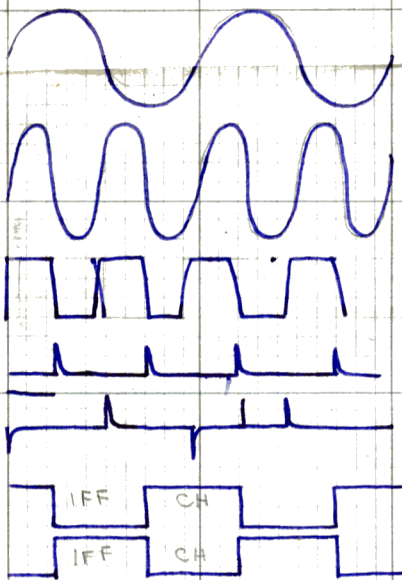

L/D  
MAINS  
V5A  
O/P of V5 to H/V 25c/s ON MAINS  
12 Sc/s ON L/D Mains amp reduced  
IFF CH  
V6 } LKI  
V7 }  
V7A  
A PLUG PIN 6  
V4A

AGC4

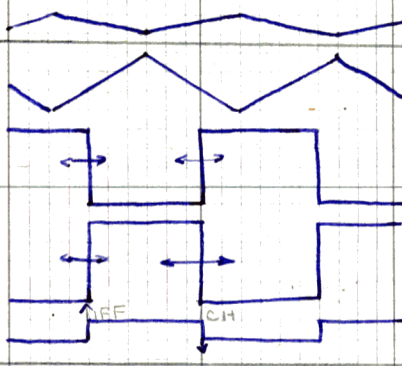

O/P medium CR. to AGC4 (AGC4 PANEL)  
V7A (25c/s scope point)  
V10A (max scope point)  
V11A (Jit " " ) } WIDTH VARIABLE  
By output of 30 TV OR.  
V12C (out scope point)

R1

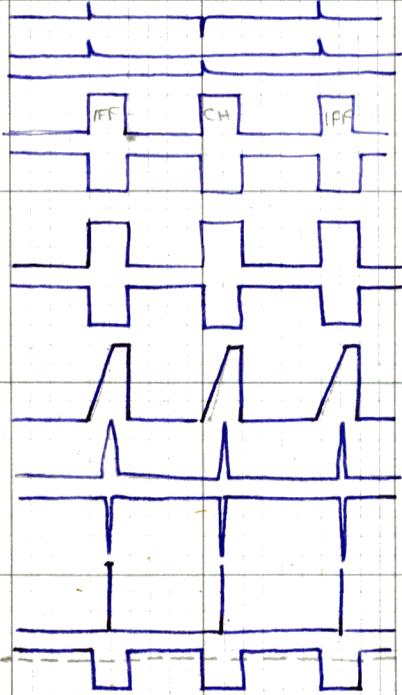

V3 suppressor/R1 maint SYNC  
V4 to gamma ray mixer  
V3A/R1  
V5A/R1 } scope V3 suppressor grid (inverted)  
V6 G/R1 } NO SCOPE POINTS  
V6 A/R1 }  
V8 G + V7A with no return pulses from CU25 } Scope  
V8 G + V7A with return pulses from CU25 } V8 G  
V8 A - scope at V8 anode } Range  
max  
V11 A, V14 C scope V14 cathode stroke  
-ve flip flop. to T/13  
V3G }  
V3A } scope at V3G & V3A.  
T/B balance scope T/B Bal. V4, V5 anodes  
V/P to V1 grid T/B bright up NO scope pt.  
B/U output  
V/P to V7 suppressor via IFF trace control  
& IFF trace B/U control  
Input to V8G & V14C stroke brighten  
V8 V9 supp grids  
B/U output to CRT cathode  
CU25 return pulse to V6 V8/R1

T.13.

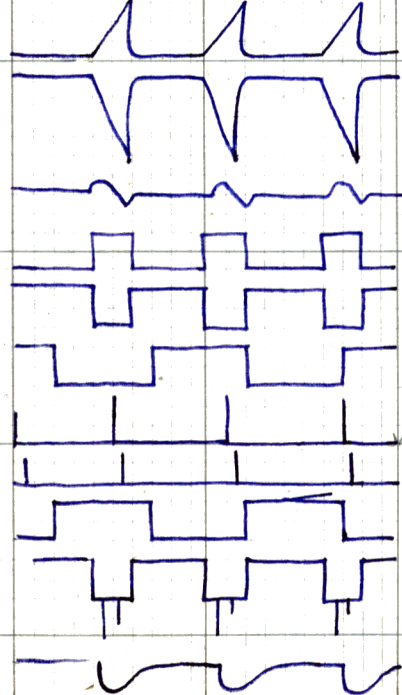

V3G }  
V3A } scope at V3G & V3A.  
T/B balance scope T/B Bal. V4, V5 anodes  
V/P to V1 grid T/B bright up NO scope pt.  
B/U output  
V/P to V7 suppressor via IFF trace control  
& IFF trace B/U control  
Input to V8G & V14C stroke brighten  
V8 V9 supp grids  
B/U output to CRT cathode  
CU25 return pulse to V6 V8/R1

Input to V8G & V14C stroke brighten



LK1 (cont.) from opposite page →

V9 + V10 -ve DCRs V9 to -ve m/v (V6)  
 V10 to +ve m/v (V7)

V11 - AGC Sync mixer

WAVEFORMS - see large sheet on previous page.

Switches

- |     |                 |                          |
|-----|-----------------|--------------------------|
| S3  | Lock down       | Local<br>mains<br>1 in 1 |
| S4. | Lock to CH Tx   |                          |
| S5. | MK III IFF      | in use<br>not in use     |
| S2. | lock from CH Tx | OK.<br>U/S.              |

controls



Pne set m/v control (lead away R's in anodes)  
 L/O Tuning (in Rec stages) RADIO LOCK Bandwidth freq. control  
 (C<sub>0</sub> in Diode cathode detector)

Power supplies from P21

- |            |   |                      |
|------------|---|----------------------|
| 250V       | { V2 anode<br>V6 anode<br>V7 anode<br>V5 screen | Sq.<br>} M/V.<br>Sq. |
| 250V stab. | { V3 anode<br>V3 screen                         | } Rec Osc.           |
| 500V       | { V5 anode                                      | Sq.                  |

scope pt.

- |          |   |                       |
|----------|---|-----------------------|
| V2 anode | — | G/R from Tx           |
| V3 anode | — | w w 250/s             |
| V5 anode | — | Input of LK1 from M/V |
| V3 anode | — | W W W                 |

V7 anode —   
 V11 anode — 

LAYOUT (LK1)

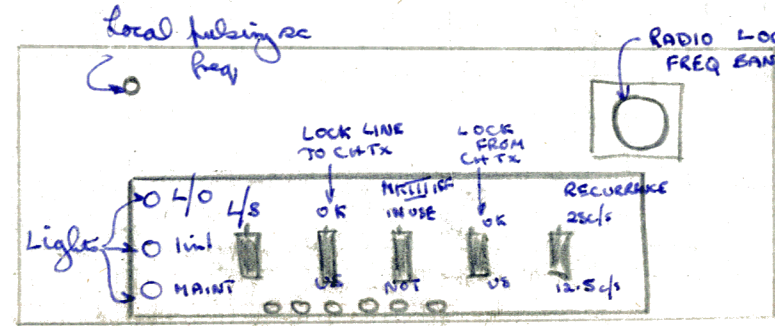
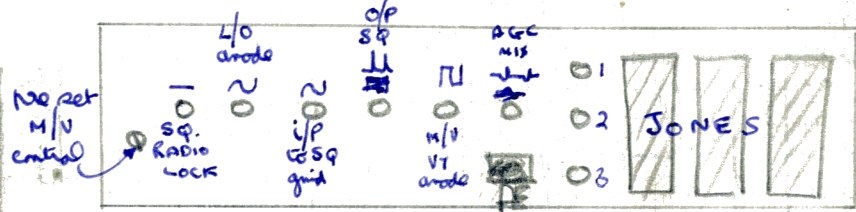
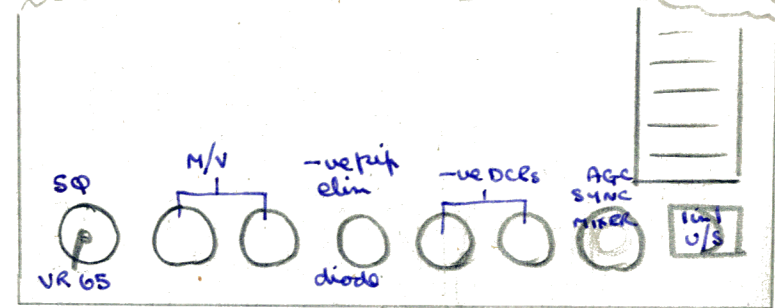
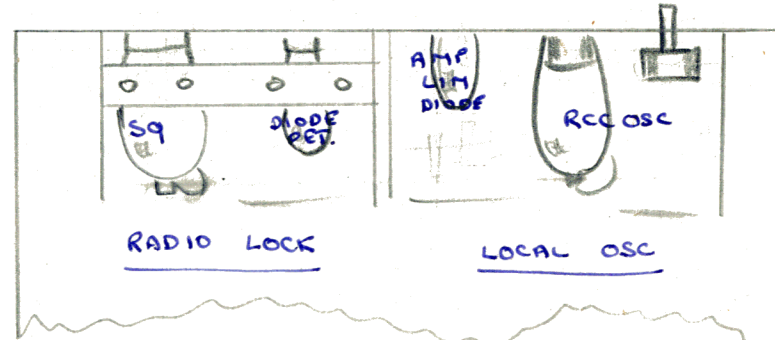

PLAN

REAR

FRONT

## LK1 Panel.

Block Diagram: — see previous pages

Purpose:

- 1) M to five CH Tx (via AGC4)
- 2)  $\square$  suppress CH signal R<sub>1</sub> during IFF periods  
" " IFF S/U and console
- 3)  $\square$  Trace sep CH Tx  
" " console  
suppress D/P console  
" IFF R<sub>1</sub> during CH periods  
" S/U ERM stereo and D.P.
- 4) accepts locking from Tx by radio link if land line faulty.

Action:

AMES Type 1 as a whole is locked by a 25c/s square wave generator in LK1. In turn this sq. wave is initially high from:—

(a) lin 1, intended to be a common locking source of all CH stations as a whole to be independent of 50c/s grid mains and its freq drift. This source is not used because of certain technical difficulties.

(b) 50c/s mains is usual source

(c) An emergency locking oscillator is used in LK1 if mains fail

V<sub>1</sub> & V<sub>2</sub> Radio reception of CH Tx Ground Ray if land line fails. S<sub>2</sub> connects R/L to GR mixers and H.T. m squares.

Lock source switching S<sub>3</sub>

S<sub>3</sub> lin 1: Provided S<sub>4</sub> is OK lock to V<sub>5</sub> is from lin 1. If lin 1 fails relay automatically transfers lock to local overriding lock source switch.

MAINS: If lock/source is in any other position and lock line from CH Tx goes U/S. S<sub>3</sub> is overridden and V<sub>5</sub> takes mains lock

LOCAL: Lock from local osc. providing S<sub>4</sub> is at OK.

Locking Summary

S<sub>4</sub> [Lock to CH Tx] at "OK" either S<sub>3</sub> a) 1:1 not used  
b) mains-normal } all via LK1 + AGC4  
c) local from V<sub>3</sub>

at "U.S" R 3016A locked by Ground Ray } Via V<sub>1</sub> & V<sub>2</sub> of CH Tx } of LK1

S<sub>5</sub> MK. III IFF "IN USE" connects land lock line from IFF Tx to R<sub>1</sub>/V<sub>1</sub>

"NOT IN USE" R<sub>1</sub> takes trigger pulse from AGC4 [object to display divider pulses]

LK1 V<sub>3</sub> L/O frequency is around 25c/s but should not be set exactly to this in order to minimise interference to other stations on chain.

V<sub>4</sub> a form of AGC for V<sub>3</sub> to maintain constant amplitude

V<sub>5</sub> is a normal square.  $\nearrow$  L<sub>5</sub> omitted

V<sub>6</sub> & V<sub>7</sub> Free running M/V should be set somewhat slower than 25c/s it can then be synced. by 25c/s sync tips from V<sub>5</sub> and will run locked at 25c/s. Necessary for -ve sync. tips on 50c/s to be eliminated to avoid uneven running of M/V so —

— V<sub>8</sub> does this on mains for 25 PRF and also for 50c/s L/O as well, on 12.5c/s PRF.

N.B. On mains lock at 25 PRF M/V freq. divides by 2 and on 12.5 PRF divides by 4.

12.5c/s PRF minimises effect of ionosphere scatter. Scatter returns from about 4,000 mb. i.e. 45 m secs. 25 PRF gives 20 m secs between traces i.e. scatter lies on alternate traces, whereas 12.5c/s has 80 m secs between traces and does not display scatter



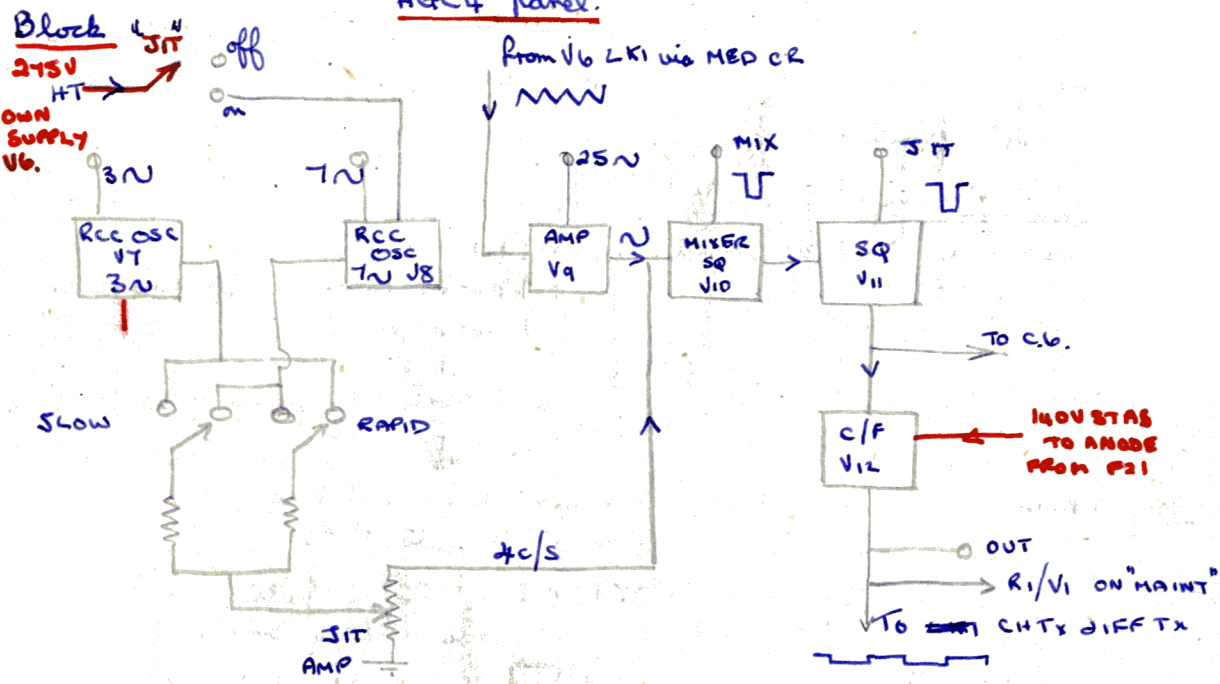

AGC4 purpose:

1. Gain reduction for first 30 miles of trace
2. Triggering pulses for CH and IFF Tx's
3. Jitter triggering and spacing during hostile interference lock at 25c/s

ACTION

IAS Pulses which fire Tx ~~are given~~ and start timebase are given on linear spacing whilst retaining retaining 25c/s PRF. Successive traces jitter irregularly but are on Ground Bay and Echo appear stationary whilst jamming pulses appear to jitter on trace.

V7 & V8: provide a source of irregular bias for V10 ∴ delay on LKI sq wave is now irregular

AGC 4 (cont.)

V10 produces sq wave which is lagging in phase relative to LKI sq wave. Tx's are fired by AGC4; muting of Rx's is obtained from LKI sq wave. Hence corresponding Rx has had time to recover from muting after Tx fires whilst the other Rx remains muted.

V11 Further squaring and amplifier producing a very sharp edged sq wave

- N.B. (a) V10 & V11 both have very short grid bases  
 (b) CH Tx fired on -ve going edges  
 IFF Tx fired on +ve " "

WAVEFORMS: — see large sheet previously drawn.

CONTROLS:

Variable resistors in grid of both osc. vary frequency  
 "SLOW RAPID": By switching in either 150K or 300K resistors into the outputs of either valve (3c/s & 7c/s) the amount of 3c/s to 7c/s and vice versa which are mixed together can be varied. If the amount of 7c/s is greatest then filter becomes faster since bias is varying more quickly. 4c/s output is varied in amplitude by the potentiometer:-

"JITTER AMP" before it reaches the Mixer grid.

SWITCHES "JIT ON OFF" switches H.T. to RCC oscillators.

SCOPE PTS.

- "25c/s" Anode of Amp V9 — 25c/s
- "MIX" sq V10 —
- "7c/s" anode V8 — approx 7c/s
- "JIT" anode sq. V11 —
- "o/p" output c/f V12 —
- "3c/s" anode 3c/s V7 — approx 3c/s



POWER SUPPLIES: Both AGC and ISAS in AGC4 have their own power unit. V6 supplies ISAS with 275 Volts. Ste c/f has supply from P.21

- 275V V6. { V7, V8, V9, V10, V11 }  
 140V STAB P.21 { V12 }

LAYOUT:

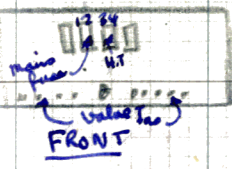
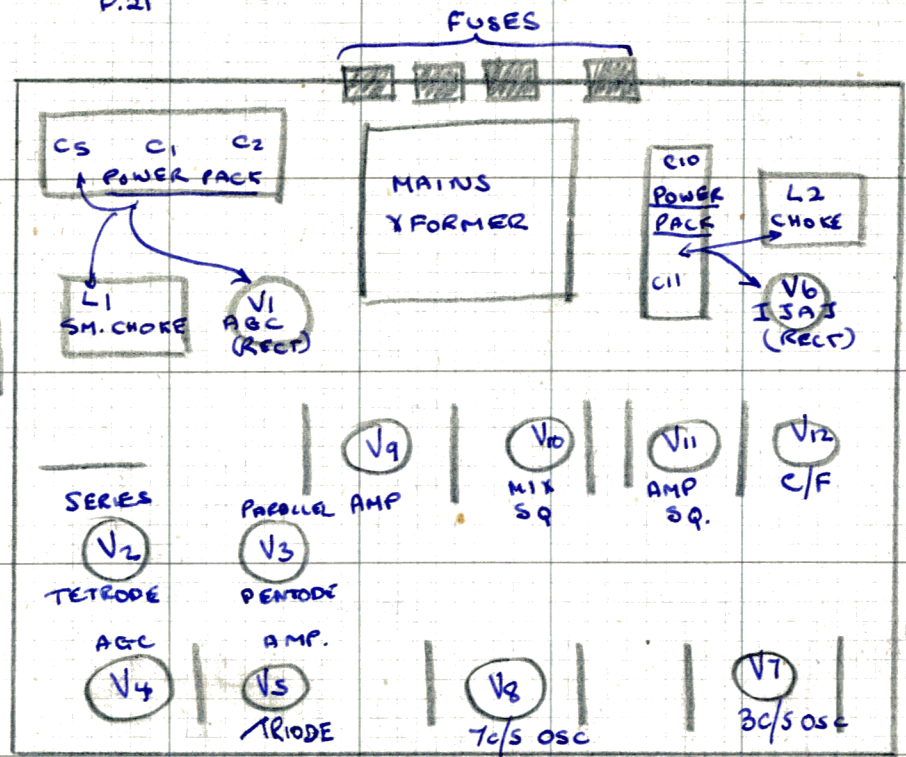

PLAN

REAR

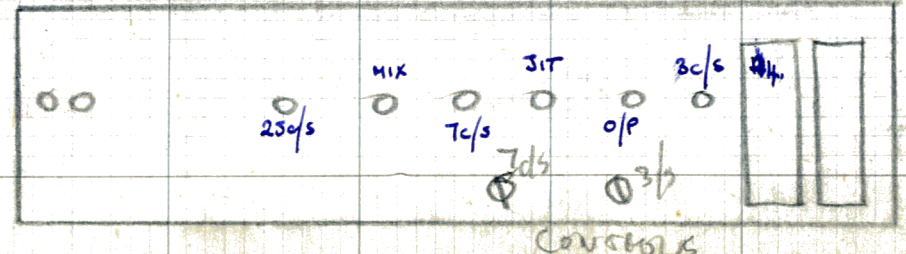

AGC BLOCK:

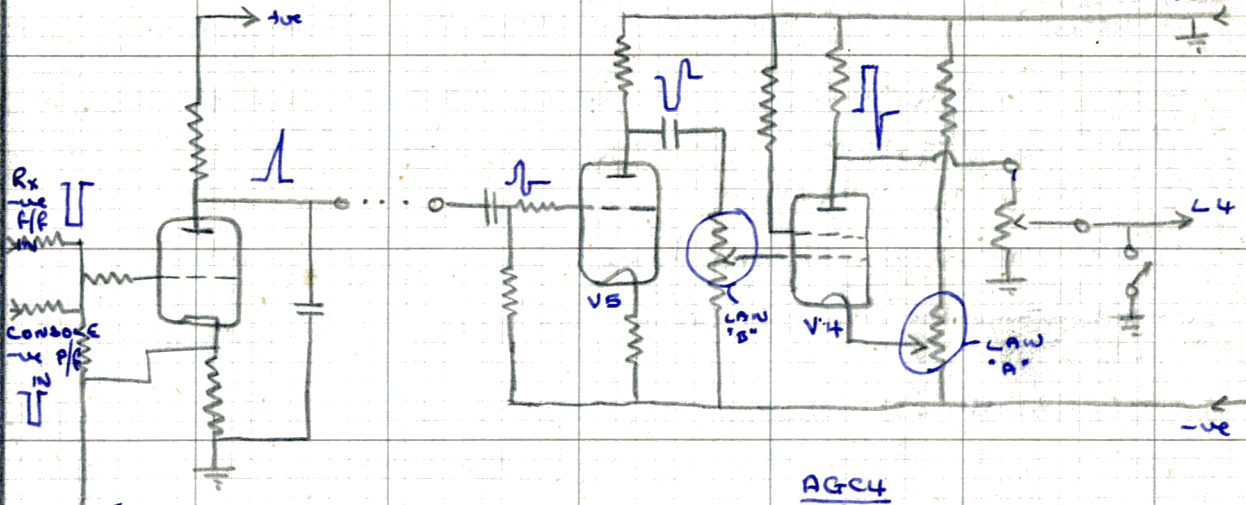
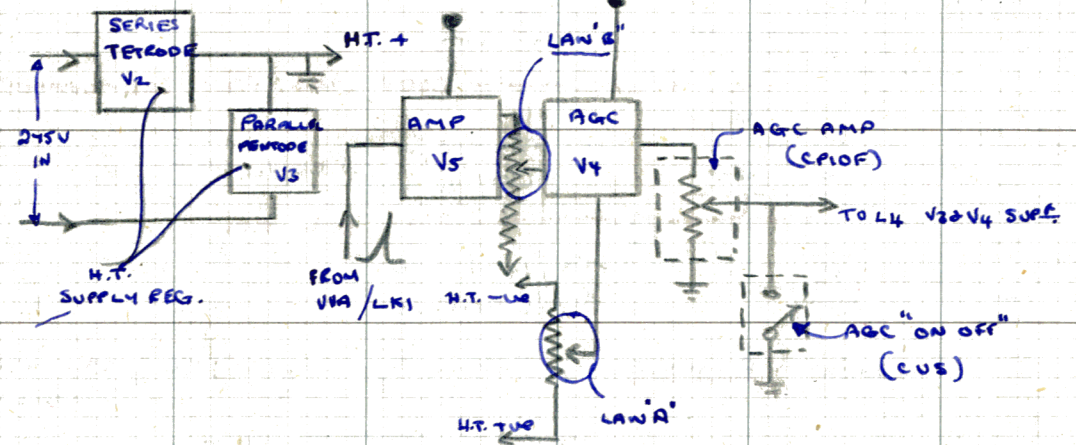

AGC4

WAVEFORMS: See other AGC4 page.

CONTROLS:  
 [AGC4] "LAWS" varies amplitude of output to grid V4 AGC  
 [REN] "LAW A" varies cathode bias of V4 AGC  
 (CP10F) "AGC amp" output of V4  
 (CUS) "AGC ON OFF" when AGC is "OFF" shows AGC is read P.T.O.



R1 Panel.

BLOCK DIAGRAM. [STROBE]

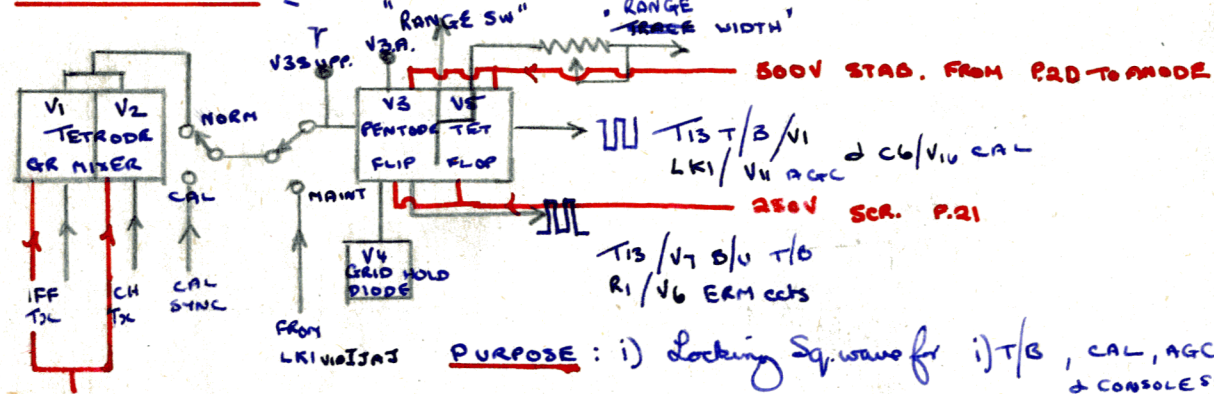

P.21  
250V ANODES & SCREENS

- PURPOSE:
- i) Locking Sq. wave for i) T/B, CAL, AGC & CONSOLE SYNC
  - ii) CH & IFF ground ray mixing
  - iii) Electrical range marking (normal)

ACTION Ground Ray mixing:  $V_1$  &  $V_2$  between pulses are cut-off by (grid) cathode bias. They conduct alternately when CH and IFF Tx's fire.

Flip Flop  $V_3, V_4, V_5$

$V_4$  diode eliminates grid positive flip at  $V_3$  grid and prevents  $V_3$  grid running into grid current and thereby reducing squareness of waveform.

N.B. Alternate sources of SYNC (a) Calibration (b) Maintenance

On these sync. there is no IFF waveform trace

WAVEFORMS:

See previous notes aiming part  
CONTROLS (R1) "RANGE WIDTH": varies ~~the~~ in grid of flip the first width of T/B B/U pulse. i.e. time when flip cuts on.

SWITCHES (OP) "RANGE SWITCH": energizes the A & B relays which puts various condensers in  $V_3$  grid according to required range 200 170 & 30 nls  
170 + } A & B energized  
30 }  
200 " deenergized NOTE also in T13  
A & B relays are

"CAL MAINT & NORM" - [ASYNC SWITCH] (LK1)

Switches in C & D relays which select the required conditions  
"NORM" - Ground ray sync  
"MAINT" - sync from LK1  
"CAL" - sync from cal markers in C6 } applied to  $V_3$  grid (Receiver flip)

SCOPE POINTS



POWER SUPPLIES

- P.21. 250V {  $V_1$  anode & Screen  
 $V_2$  anode & Screen
- P.21 250V {  $V_3$  } Screens  
 $V_5$  }
- P.21 500V STAB {  $V_3$  } anodes  
 $V_5$  }

R1 Panel

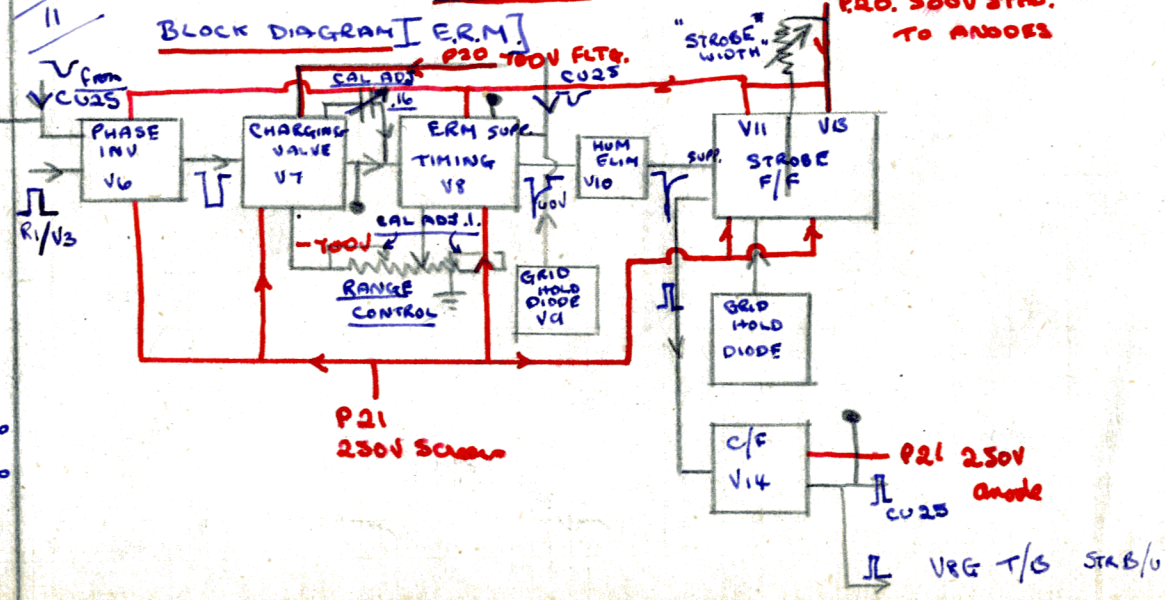

ACTION ERM production:

Charging and Timing

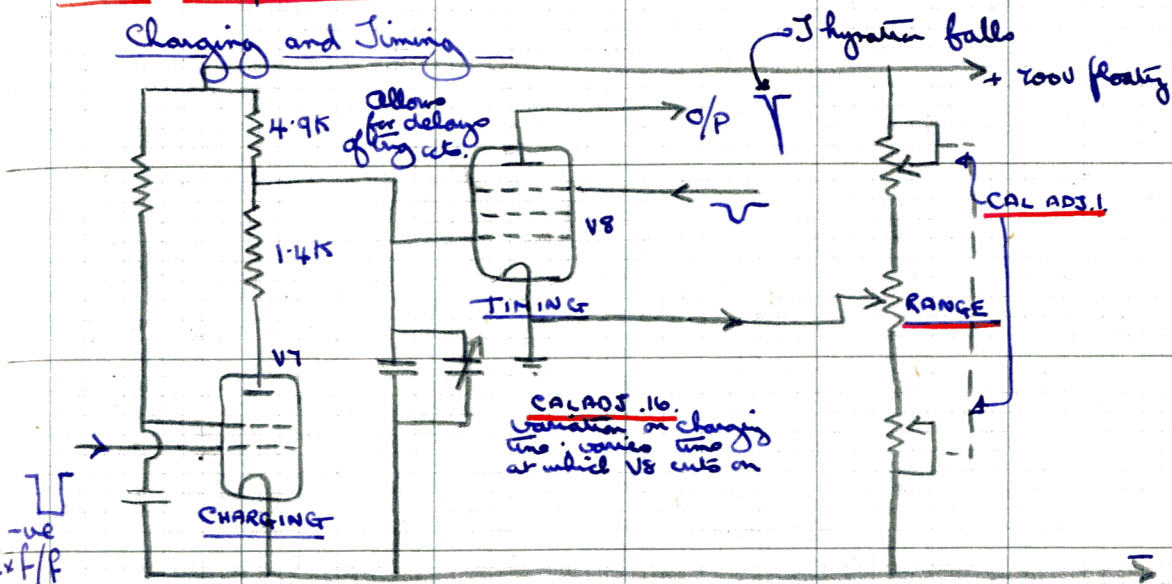

The +ve flip flop sq wave inv by V6 applied to trigger V7 central grid [V7 conducting producing at anode a voltage which applied to V8 central grid holds that valve "cut off"] The now negative sq wave cuts off V8 whose anode voltage rises, the rate of rise retarded by the need for charging the anode condenser. When its voltage between grid and cathode of V8 is sufficient to overcome the bias, V8 conducts producing in its anode a waveform whose leading edge is overcompensated exponential. That leading edge triggers the strobe f/f whose +ve output after short delay is used to trigger a thyatron [CV25] the resultant waveform in anode of thyatron is a flip whose leading edge is very fast. Also a return is taken from the thyatron anode to cut off V8 (R1) on its suppressor grid and hold it cut off for a length of time which exceeds the T/B time since that pulse is also applied to hold V6 cut off. The result is a very narrow flip whose position within the T/B triggering sq. wave depends on  
 (a) the bias between V8 grid and cathode  
 (b) value of anode condenser.

Extra gen  
ERM measures range accurately without using coils cal markers

and it is independent of linearity of T/B. Calibrator is only used

- (a) To initially calibrate ERM.
- (b) If ERM fails.

ERM is electrical stop watch, correct to 3 usec, which is started when Tx fires and stopped by setting of range control. At instant of stopping it gives RM pulse which forms an electrical pointer. Range accuracy + 1/3 of a mile.

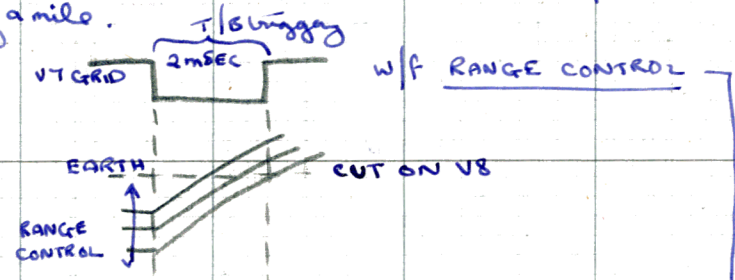

WAVEFORMS: SEE PREVIOUS PAGE & ABOVE

CONTROLS:

- (CP10G) "RANGE CONTROL" alters the exponential rise at V7 anode which eventually cuts on V8. Actually in V8 cathode across 100 volt
- (CP10H) "CAL ADJ 1" has similar but finer effect than "RANGE" used to compensate for zero error. First cal flip should be on red line. In series with range control.
- (CP10I) "CAL ADJ 10": Effect is to compensate for variation in time constant circuit between V7-V8. Set red line to 10th cal flip. Varies condenser in anode of V7 charging value.

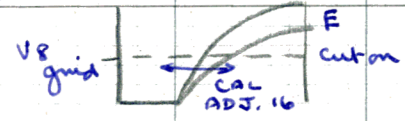

"STROBE WIDTH": Varies resistor in grid of V11 (flick of strobe f/f) the time at which flip cuts on.

SWITCHES:

SCOPE P.T.S.

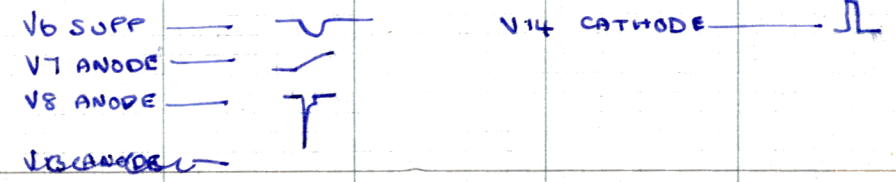



R1 TOWER SUPPLIES

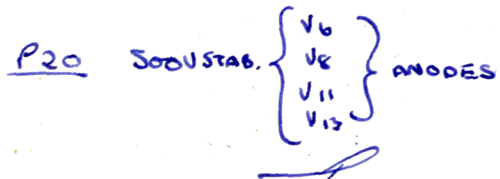

V10, 11, 12, 13

15-30 W sec FLIP/FLOP used to trigger  
(a) Strobe B/O  
(b) Generate ERM pulses  
or CU 25/V11 by  
(c) Also used in console

LAYOUT!

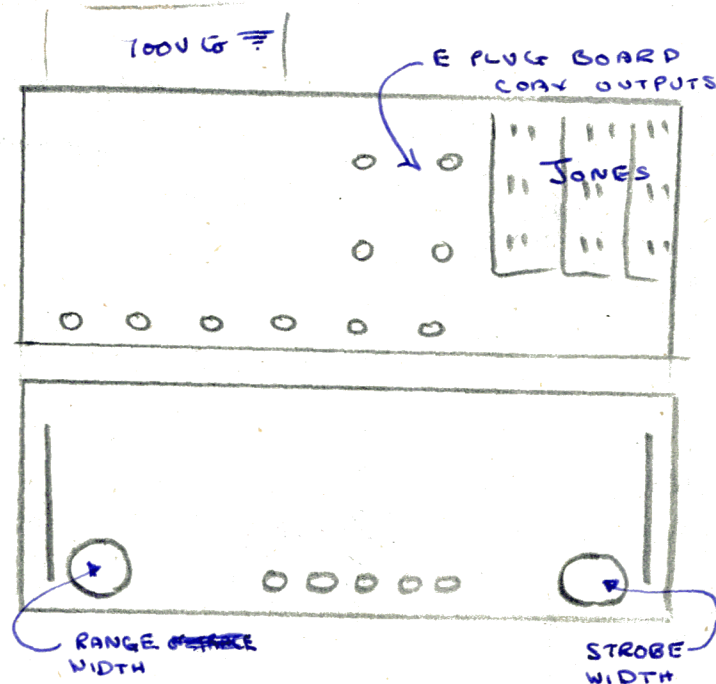
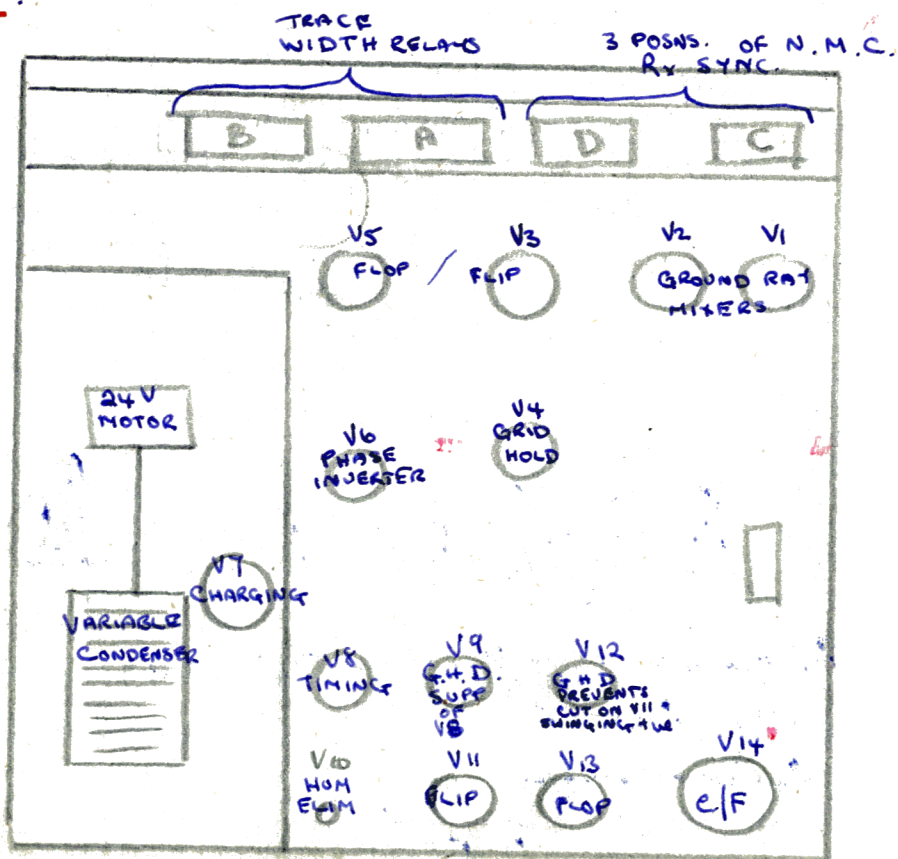

CU 25 Panel

Block:

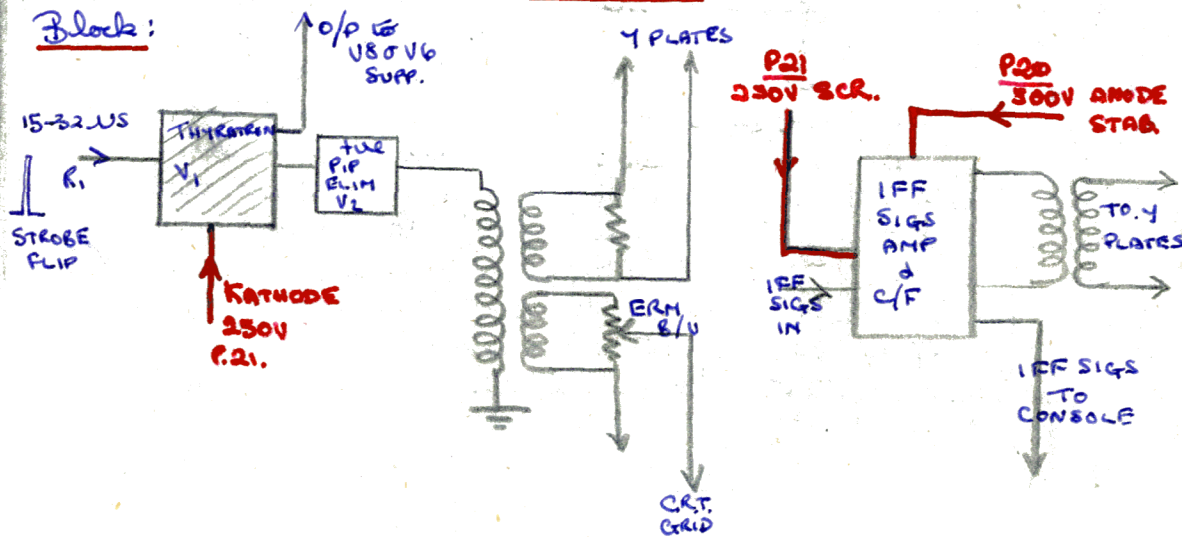

PURPOSE: a) To help in the production of ERM i.e. produce -ve pulses for supp. of  $V_{B}$  &  $V_{S}$ .  
 b) IFF sig. amp. Amplifier takes off feed to 1 plate off X-former in anode circuit.

Reason: a) (cont) This ensures (a) Only one RM per pulse  
 (b) Sharpness of  $V_{B}$  anode w/ form  
 (c) Prevents  $V_{B}$  running into excessive grid current

ACTION:

V1 The positive pulse from the c/f cuts the thyatron on and a negative going pulse is developed in its anode which is fed to  $V_{B}$  &  $V_{S}$  suppressors slowly rising exponentially.

V2: So a +ve trip eliminator

Waveforms:

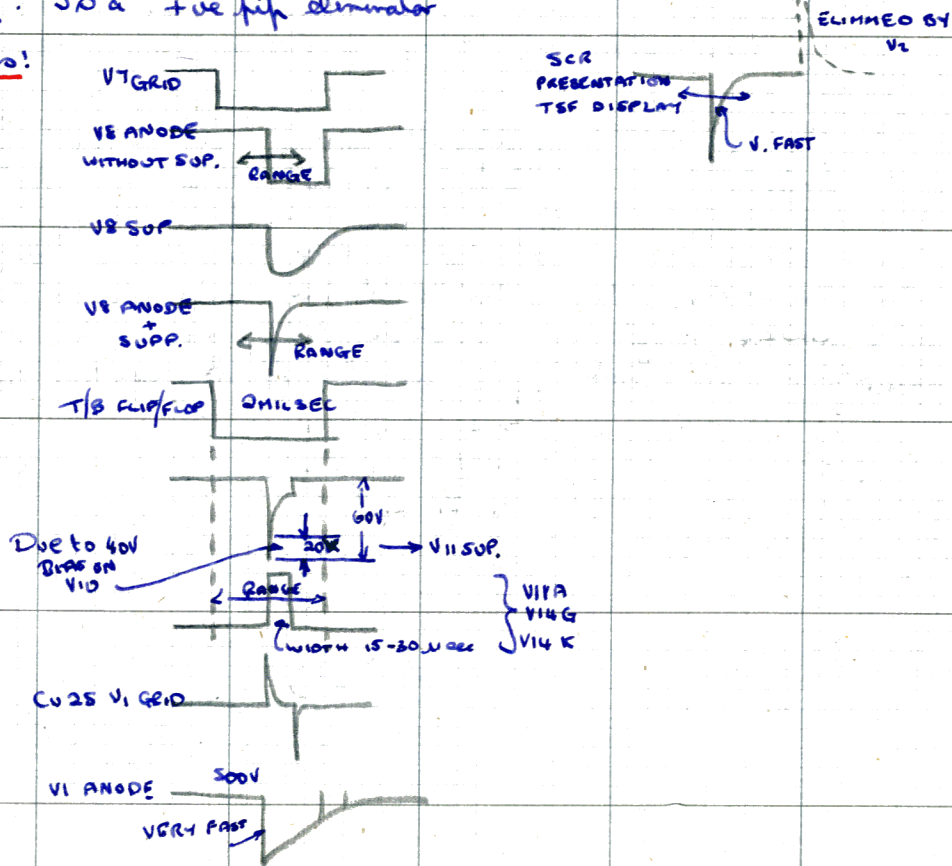

CONTROLS: "ERM B/U" varies resistance across secondary of X-former in the pipeline load. The output to CRT grid is therefore varied.

SWITCHES:

SCOPE PTS:

POWER SUPPLIES:

- P21 250V }  $V_1$
- P21 250V } SCR. IFF SIG AMP
- P20 500V STAB. } ANODE IFF SIG AMP

LAYOUT:

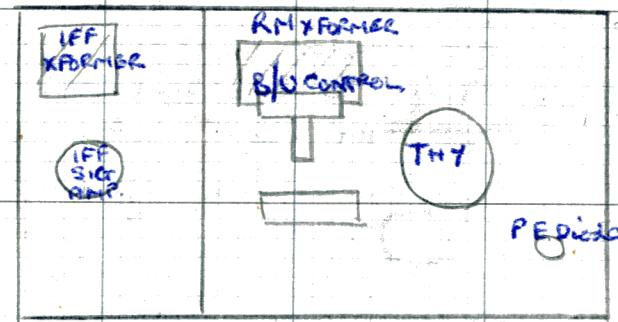

IFF SIG AMP ACTION & CONTROLS:

The sig from IFF receiver are applied to grid of  $V_3$  via centre cap on grid coil. They are applied after amplification to a X-former in its anode and thence to 1 plate. There is also another output to anode from cathode.

SWITCH: In screen of valve circuit IFF ON/OFF.

POWER SUPPLIES: As above.

LAYOUT: See above diagram.



# AGC 4 (Cont)

## WAVEFORMS:

**ACTION:**  $V_1$ ,  $V_2$  &  $V_3$  full wave rectifier producing 275 volts after passing through the regulating circuit comprising  $V_2$  &  $V_3$ .  $V_5$  receives +ve going saw tooth from  $V_{II}/LKI$  and amplifies and inverts it before applying to  $V_4$  grid via "LAW B" potentiometer which controls the amount of sawtooth to be squared.  $V_4$  normally conducting holds suppressor grids of 3rd & 4th I.F. at potential -ve to earth determined by conduction of  $V_4$  set by "LAW A" potentiometer. The sawtooth squared +ve going at  $V_4$  anode takes the I.F.'s suppressor towards earth potential thus increasing their gain. H.T. +ve is earthed so that suppressor grids do not have high D.C. potential on them.

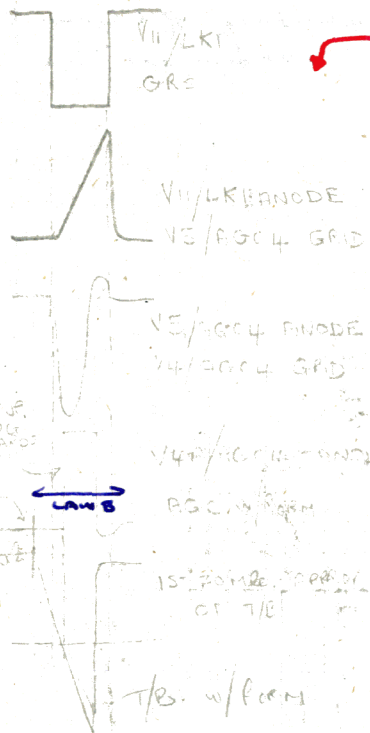

## WAVEFORMS:

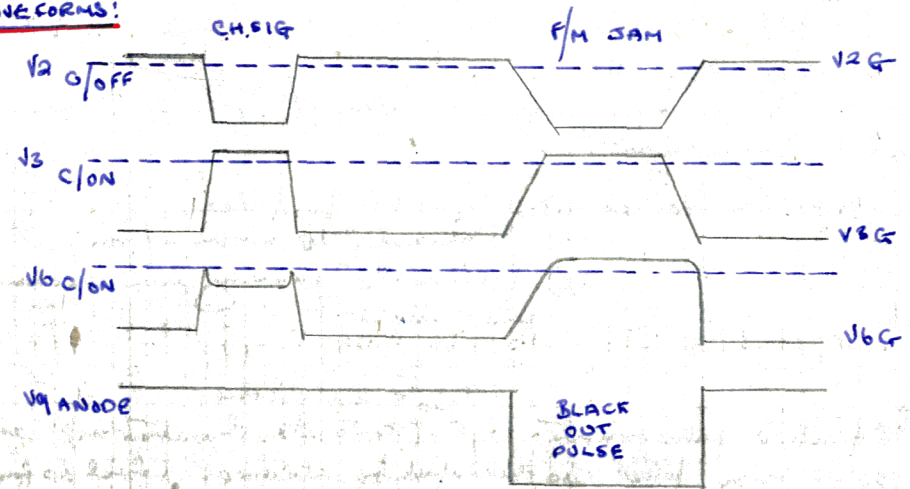

**ACTION:**  
**PURPOSE:** To black out the portions of the trace distorted by frequency modulation jamming to reduce the fatigue of the operator.

**ACTION:**  $V_2$  normally conducting;  $V_3$  cut off the output of the signal chain applied -ve to  $V_2$  +ve to  $V_3$ . Biasing arrangement so that  $V_2$  cuts off before  $V_3$  cuts on. In fact rising waveforms this time is small. But for w/f whose rise is slow by comparison the time when both  $V_2$  &  $V_3$  are cut off is long allowing common anode to reach a voltage sufficient to cut on  $V_6$ .  $V_6$  anode is coupled to  $V_3$  suppressor thus holding  $V_3$  cut off for the duration of the pulse even though  $V_3$  grid may have passed its cut on biased point. The output of  $V_6$  is applied to  $V_8$  for amplification stereo to  $V_9$  which produces -ve going electron pulse for application to CRT grid.

Should have spikes of noise or C.H. signals of sufficient amplitude to eventually cut on  $V_6$  the anode. C.R. of  $V_8$  discriminates between these and jamming by leading towards long CR to noise and signal and shorter CR to frequency modulated jamming (wide in time). Thus  $V_8$  anode does not rise to 0 potential large enough to cut on  $V_9$  whereas for the wide jamming pulse

## AJBO [Anti Jamming Blackout]

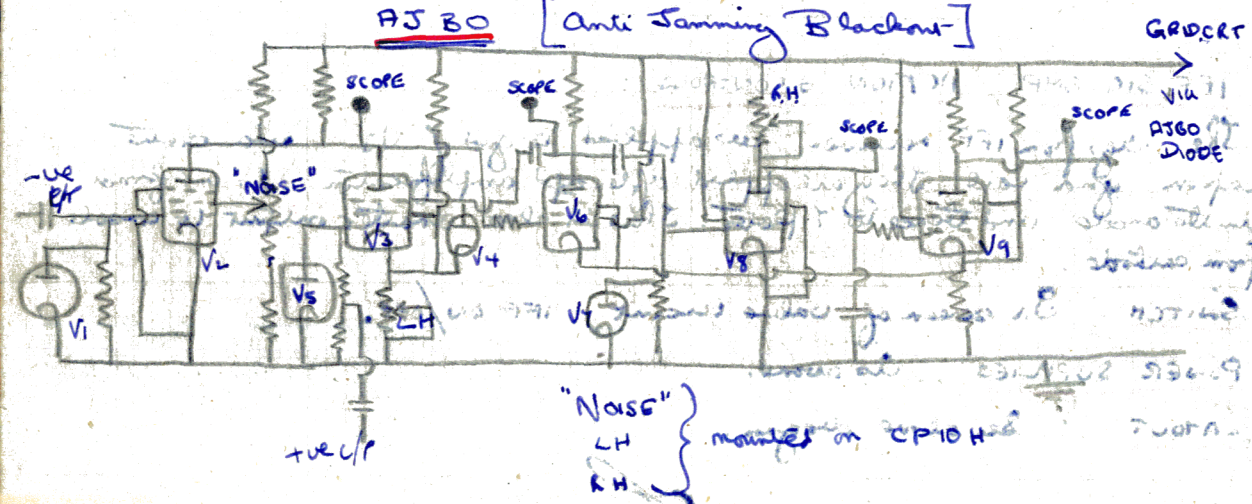



- V<sub>9</sub> does cut on.
- V<sub>1</sub> grid hold diode (-ve).
- V<sub>5</sub> " " (+ve)
- V<sub>4</sub> Sup " " (-ve)
- V<sub>7</sub> grid " " (-ve)

POWER SUPPLY:  
Self contained [from regulated mains] of 275 volts H.T.

CONTROLS  
(CPIO H)

- "NOISE": Screen of V<sub>2</sub> varies voltage on beam and therefore noise [greater voltage greater noise]
- "L.H.": Varies bias on V<sub>3</sub> this tube when it cuts more off. Control of V<sub>3</sub>
- "R.H.": Anode of V<sub>8</sub> varies amplitude of output

SWITCHES:

LAYOUT:

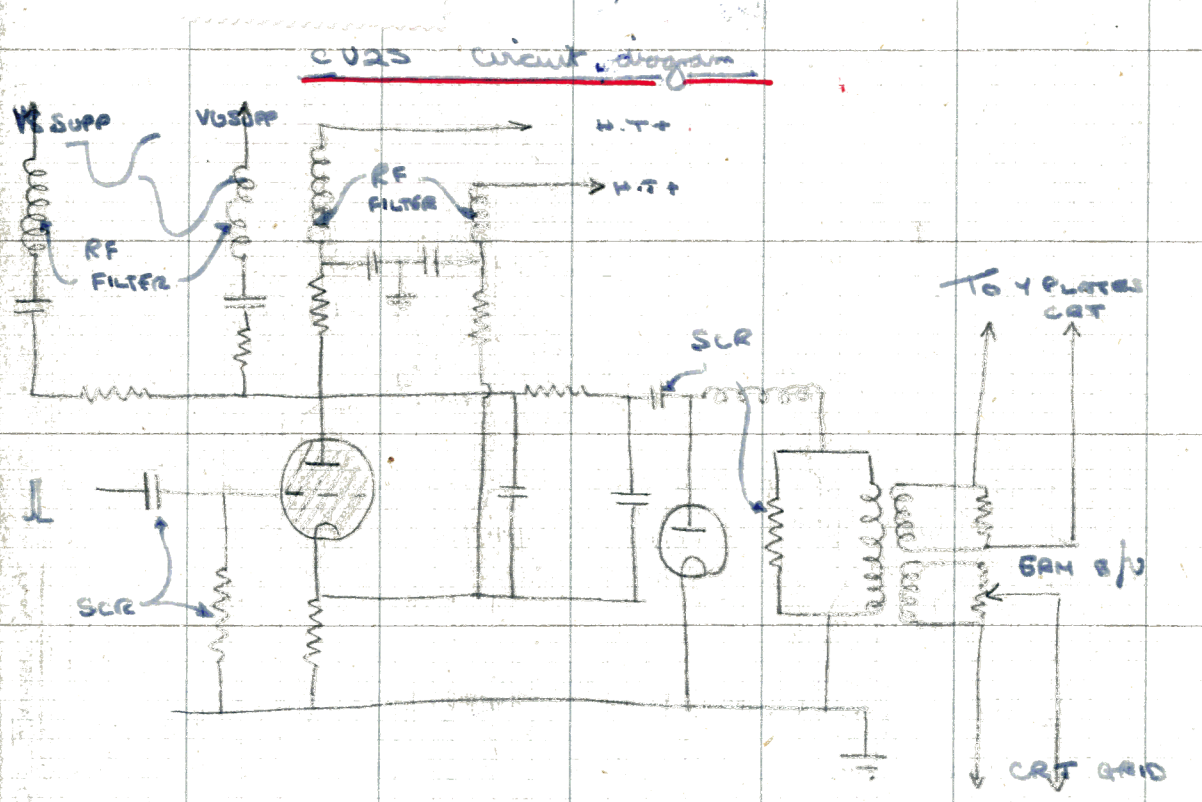
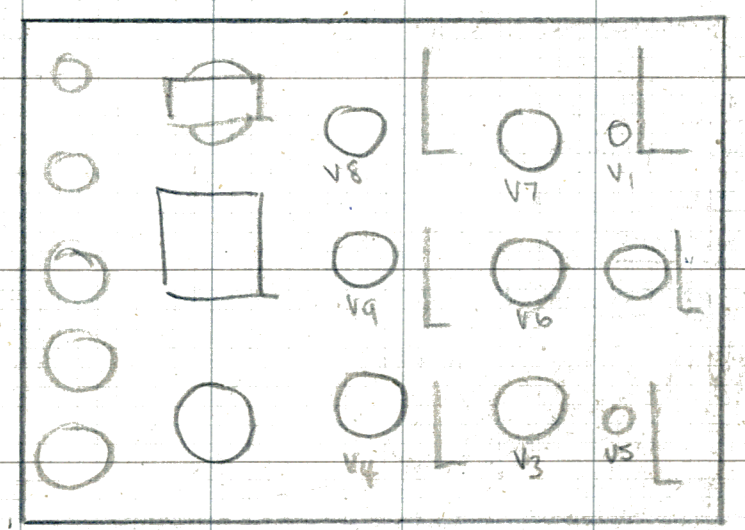

T.13 Panel

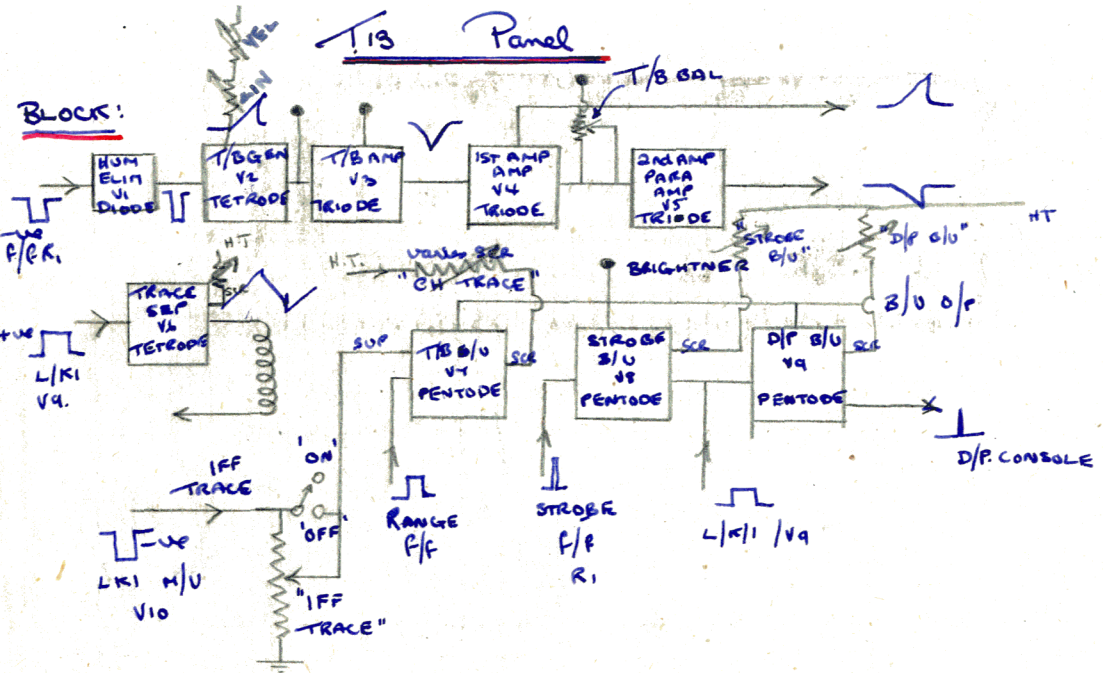

ACTION: V1 Removes first 10 volts approx of the flip/flop triggering pulse. Cathode biased 10 volts -ve. The hum picked up and occurs between flip flop cycles.

V2 Timebase generator of the simple type its valve charging selected anode screen condensers for its different ranges. Relay selection  
 (A) energized for 10ms  
 (B) " " 130ms.  
 neither energized for 200ms.

CONTROLS: "LIN" varies charging rate of anode C. S1 anode of V2 on 200ms ONLY "IC" varies anode pot. of both condensers. Diag filter

V3 Amplifier

V4 } Paraphase amplifier providing balanced outputs to  
V5 } C.R.T. X plates. T/B balance control adjusts grid cathode feed of second valve to balance its output to that of its first

V7 T/B brightener CH trace brilliance varied by potentiometer in screen circuit; IFF trace brilliance varied by potentiometer

application of the whole or selected portions of the -ve. m/v sq wave from L/K1 anode suppressor grid.

CONTROLS: "CH Trace", "IFF Trace", "IFF trace" switched - see diag  
"Strobe brilliance" varied by potentiometer in the screen circuit valve being cut off during CH periods. V8  
"D/P brilliance" varied by rat. in screen of V9 valve cut off during CH period. \$

V8: Strobe brilliance varied by potentiometer in the screen circuit valve being cut off during CH time period by multi/alt sq. wave which is negative going during that time.

V9: D/P brilliance by varying screen potential cut off during CH time period by M/V output which is -ve during that period. D/P is generated in console type 3 and used to trigger V9.

WAVEFORMS:

See previous page

CONTROLS: see rate in ACTION ALSO "TRACE SEP" Varies STR V6 (T.13)

SWITCHES: " " " "

SCOPE PIS: V3 GRID —

V3 ANODE —

"T/B ONL" —

"Brightner" V7, V8, V9 ANODES —

POWER SUPPLIES:



POWER SUPPLIES:

- 1200V P20 { V2, V3, V4, V5 } ANODES
- 500V P20 { V3 } ANODE
- 500V P.21 { DEP COILS (TRACE SEP) } ANODE & SCREEN { V.7, V.8, V.9 }
- 250V ANODE & SCREEN P.21

LAYOUT:

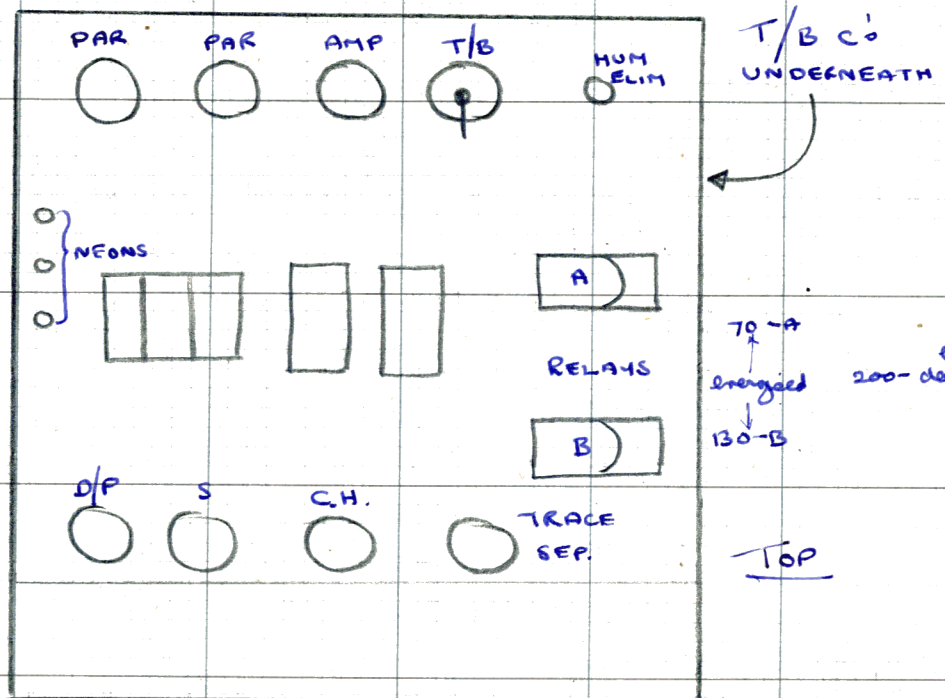

TOP

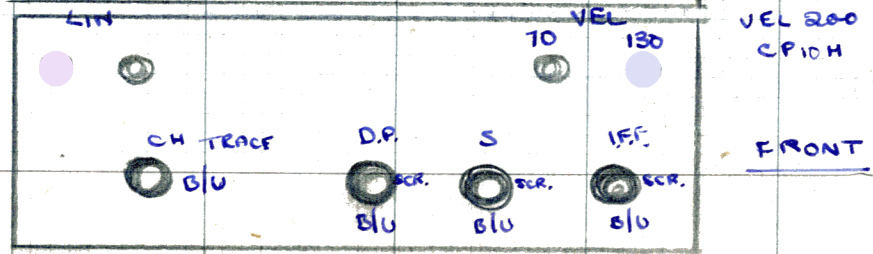

FRONT

PURPOSE:

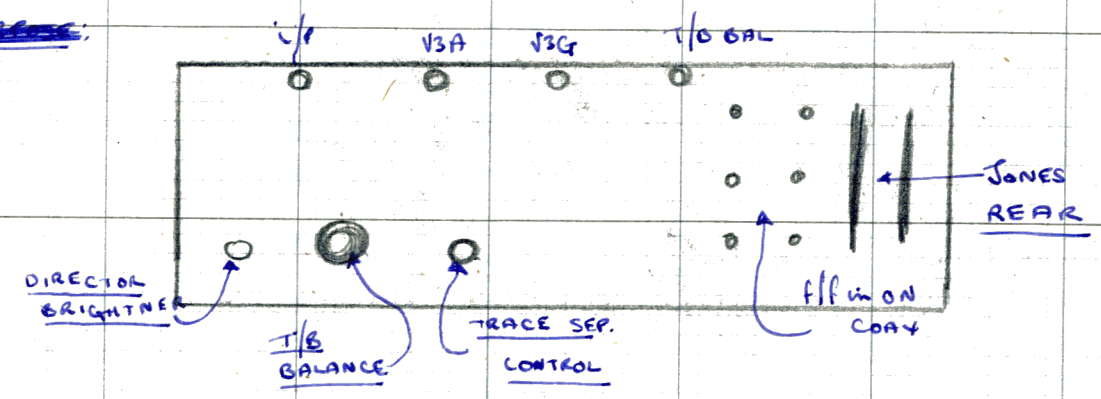

PURPOSE:

From the past notes it can be seen that the purpose of T/B is.

- (a) To provide a T/B
- (b) " " Trace separation.
- (c) To provide B/V's for strobe T/B & D/P.

ERRA NOISE

T/B circuit

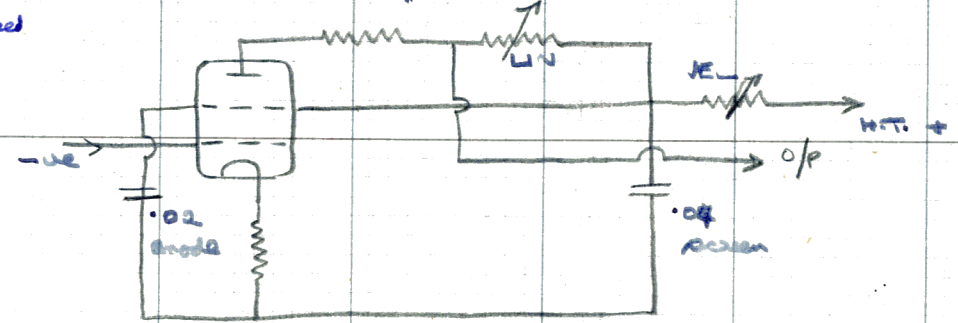

1st valve; Diode receives on cathode -150 sq. wave from flip/flop  
 → grid of second valve times two. Diode starts off first 10 volts of  
 input waveform because during time between f/p pulses hum occurs  
 ∴ bias removed so that it does not allow triggering of V<sub>2</sub> or after  
 on T/B. Cathode biased 10 volts less so before it conducts incoming



voltage must swing beyond 10 volt -ve.

1/2 T/B gas, simple T/B gas employs titrade. Relays are engaged to provide 200ml T/B. Cat. smoothes itself into about diagram.

-ve going sq. wave cuts off valve - anode and screen rise to H.T. But condensers rise through resistance network. anode C.O.U.F screen - O+U.F. They charge at different rates. Total charging rate governed by CR's -ve resultant is a fairly straight line charging rate. as the end of sq. wave, valve conducts and shorts out condensers.

One velocity control for each of the ranges it varies aiming pot of both condensers. It varies charging rate of anode condenser.

Relays employed for changing of resistors valve this is removed by alone to be replaced by two fixed resistors.

Across screen circuit - Co are zero, purpose, to protect Co in a tendency to overcharge -ve using a 70 ml. T/B on input square wave sufficient to produce a 200 ml. T/B i.e. it is wide.

V3 is T/B amplifier  
V4 & V5 Para amps as described.

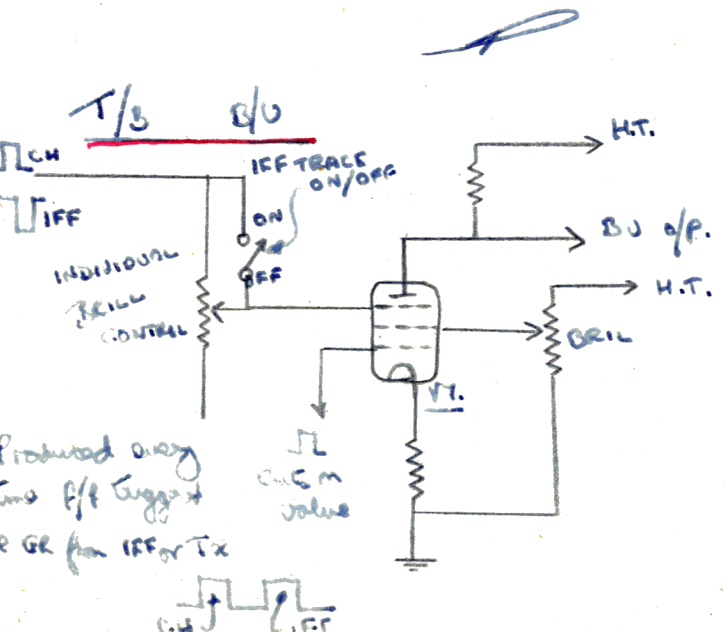

Strobe B/U Vr

Same except that triggering w/p comes from f/f in R1. Occurs in range flat flat pulse

Strobe occurs everywhere with ERM. Anodes of B/U are strapped together and have a common load. ∴ outputs are mixed and result is as follows

During CH time period strobe must be put away so once M/V is used, +ve IFF to suppress Vr, it cuts on and produces a kink on output pulse. Only when IFF trace being displayed.

D/P B/U V9 again a pentode D.P. produced in anode T3 fed to control grid and is a very narrow sq. wave. During CH time period V9 must be cut off so that D.P. is not showing.

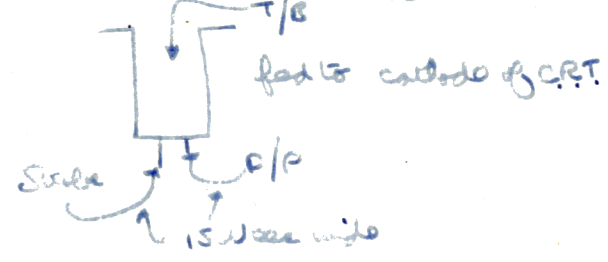

C6 PANEL.

PURPOSE: To provide narrow 1.5 usec cal tips to off to T/B during its time period.

C6  
POWER SUPPLIES:

P21 500V } V6 ANODE

OTHERWISE C6 HAS ITS OWN POWER H.T. OF 250 VOLTS

LAYOUT:

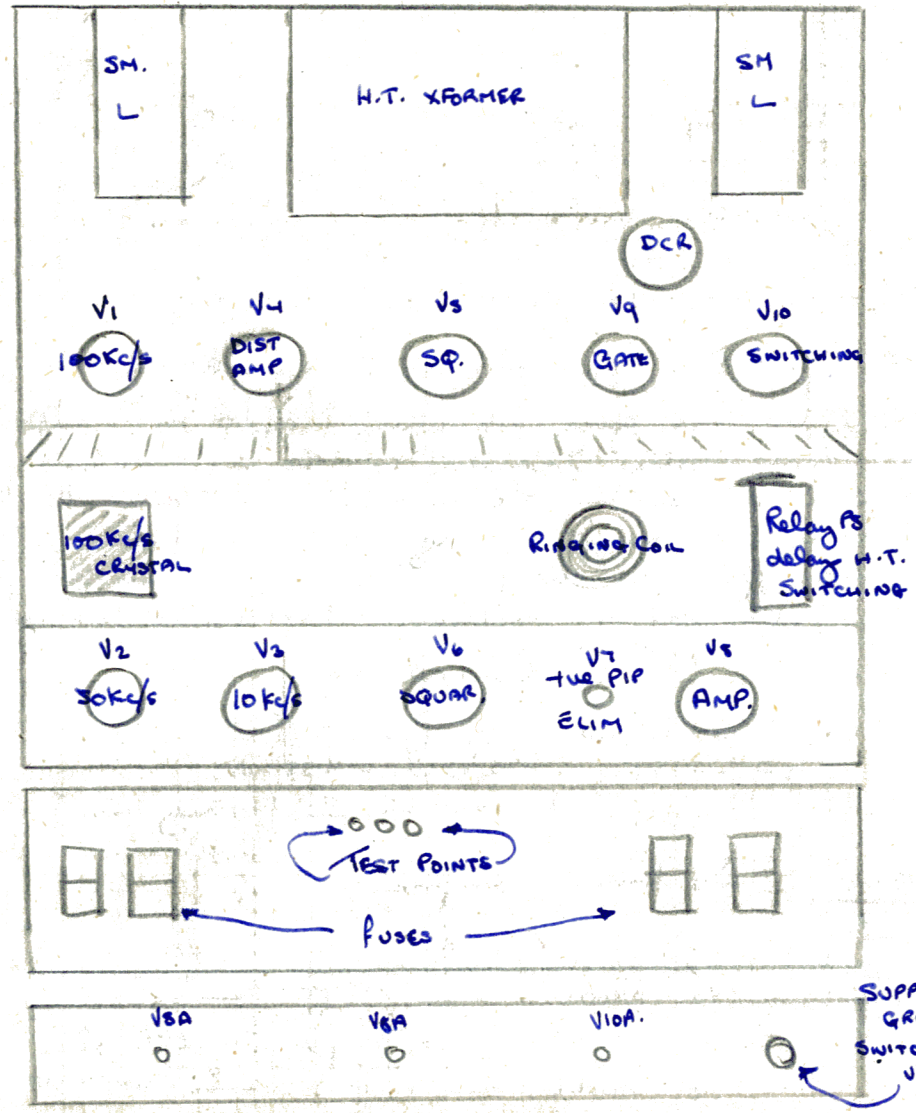

CRO POWER UNITS

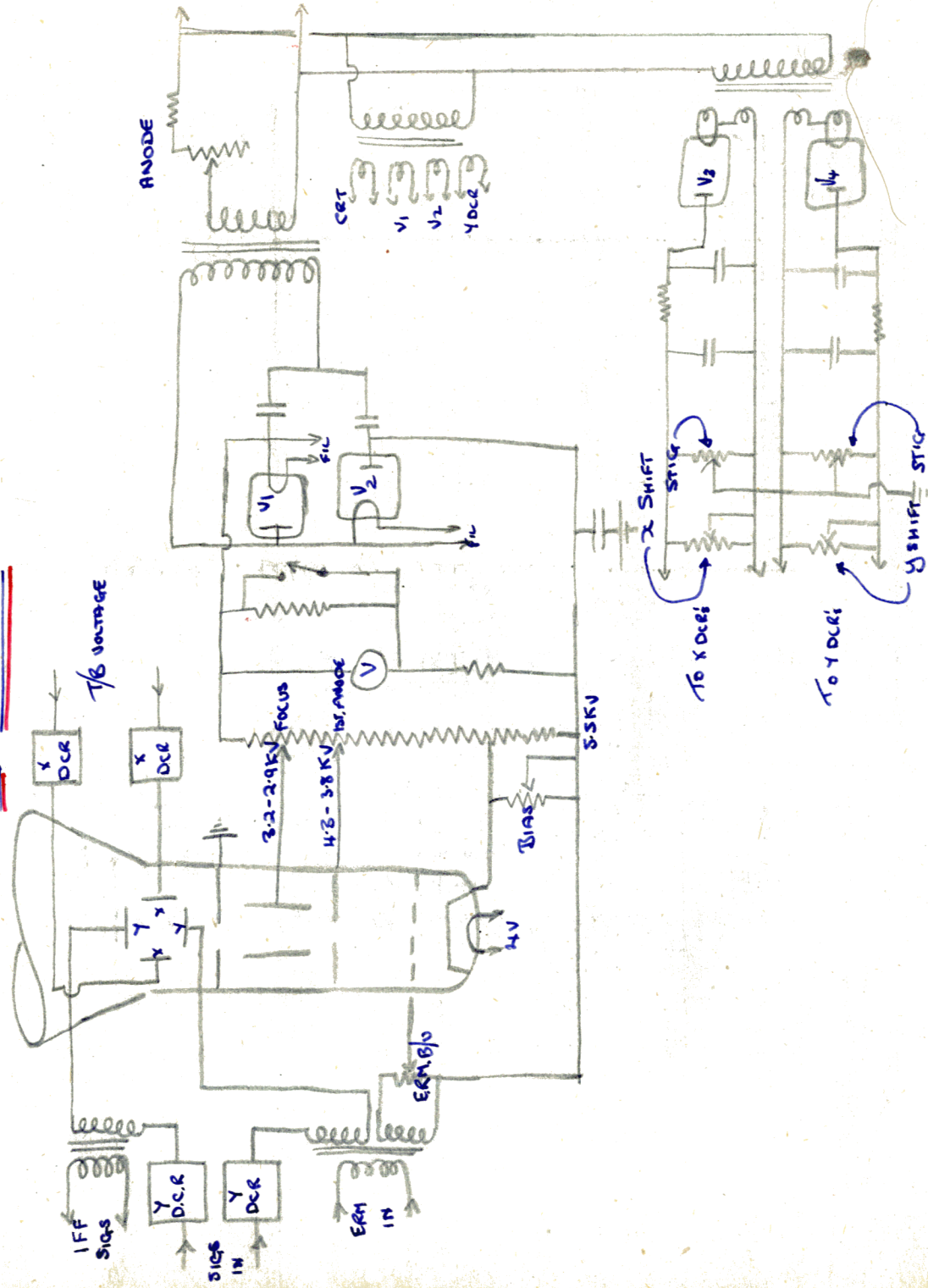



EHT Power Unit

LAYOUT:

THE CONTROL ADJUSTED WHEN NEW TUBE REPLACED

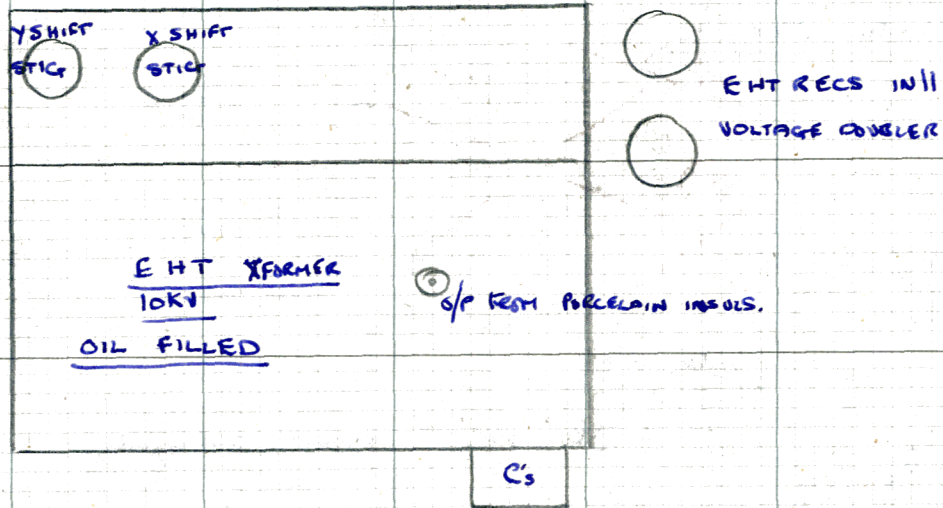

E.H.T. Power Unit

FRONT PANEL:

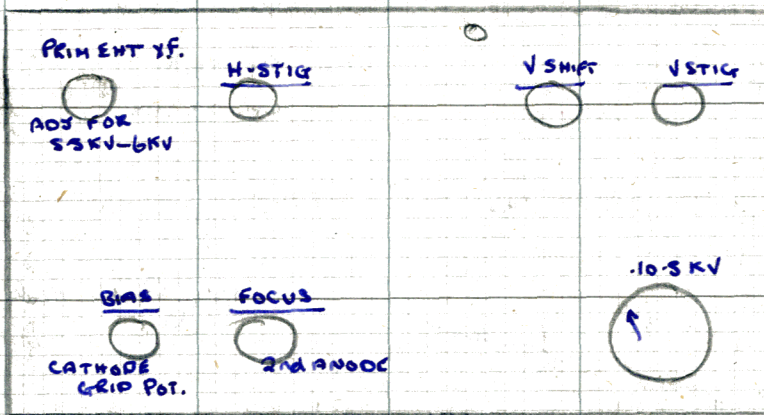

CRO PANEL LAYOUT

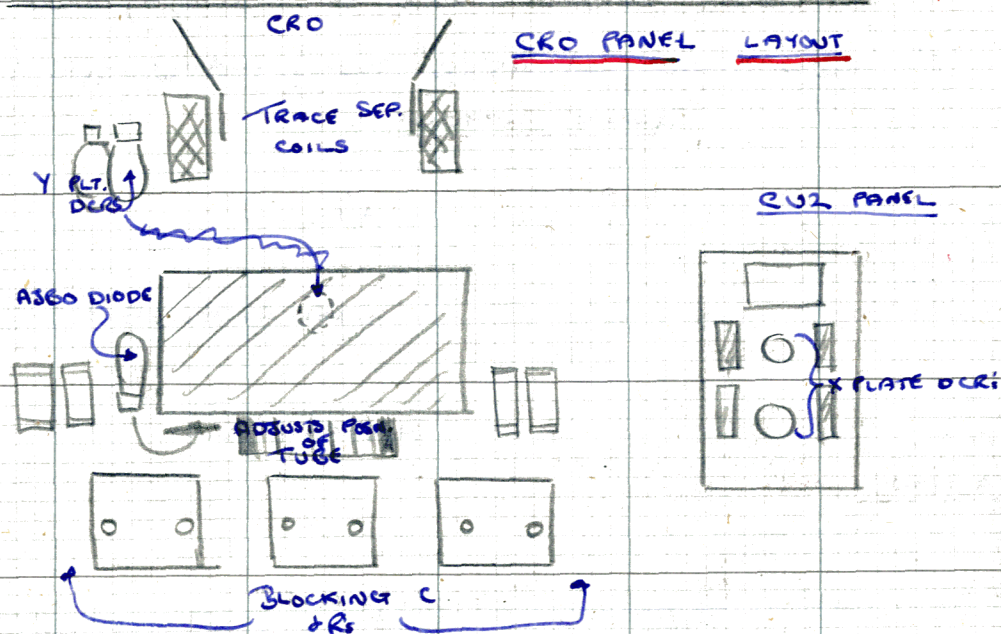

SWITCHING

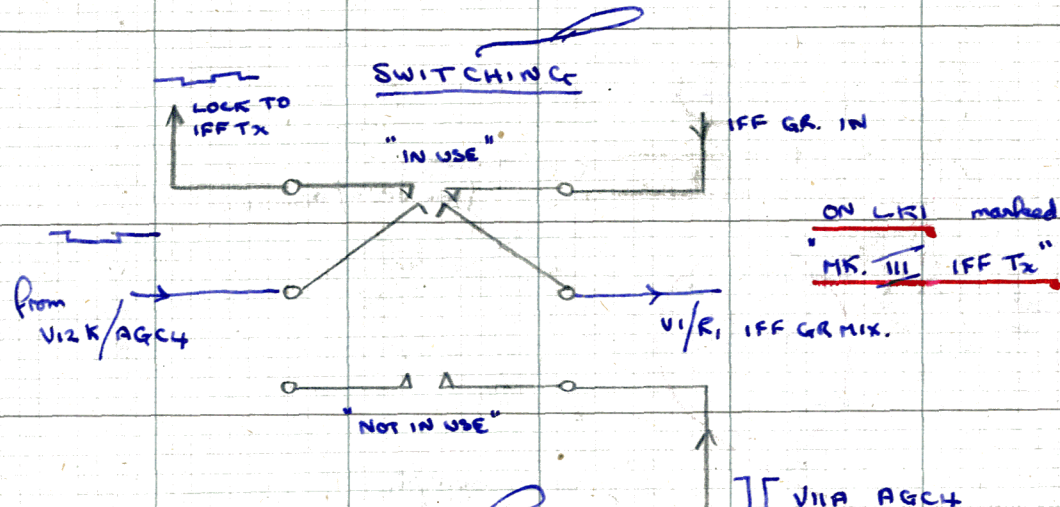

TRACE O/U VALVE & CONTROLS

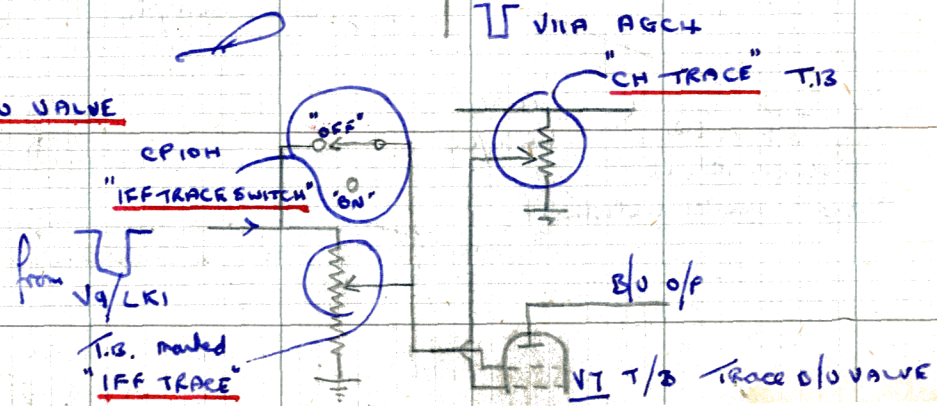



Lock to CH T2

Load Source

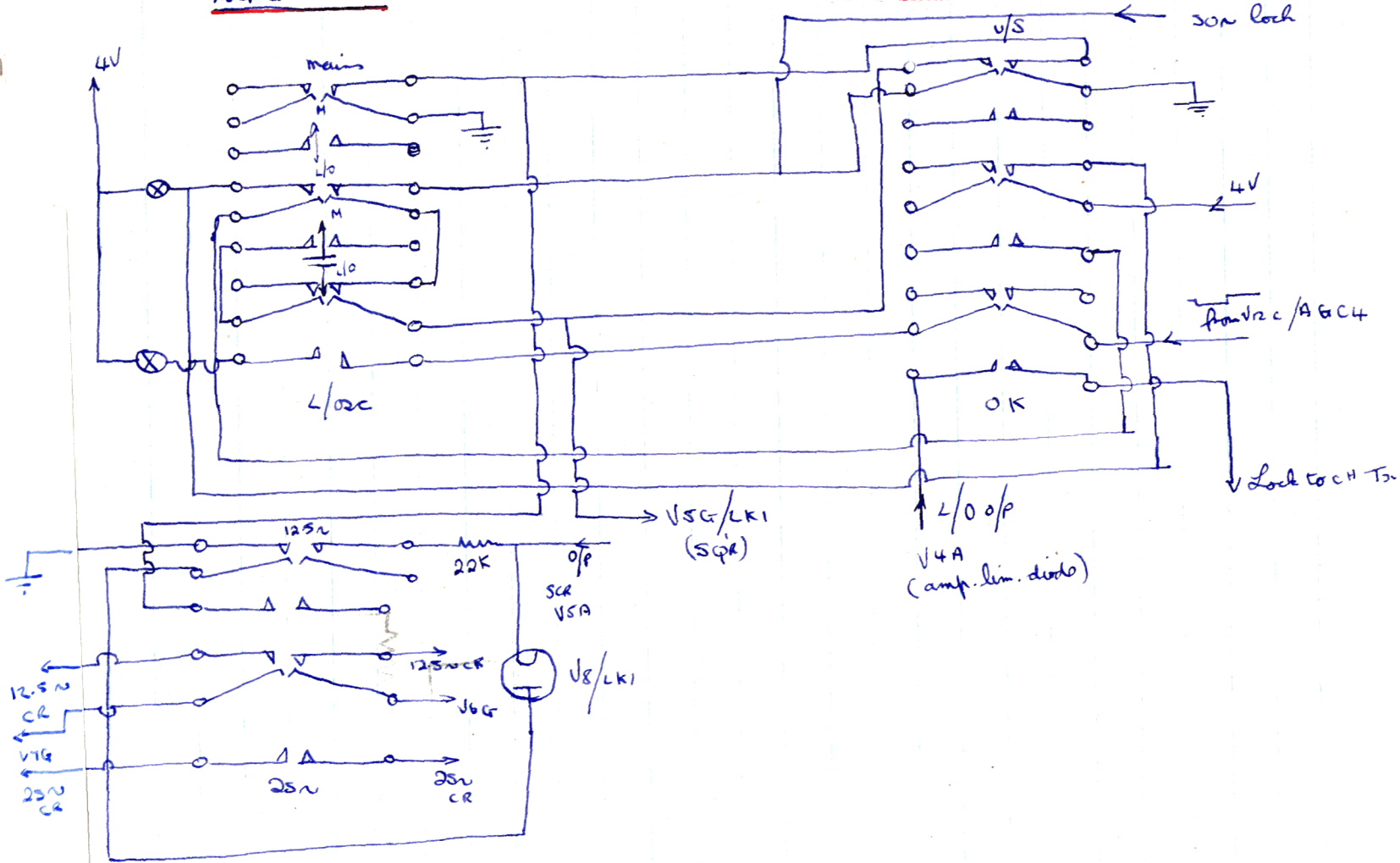

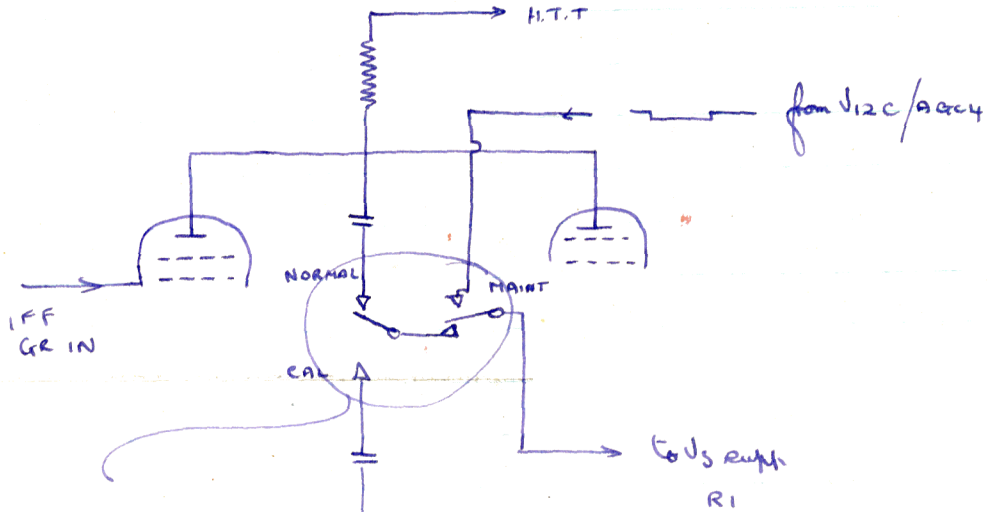

Contacts of C/O  
 Relay R<sub>1</sub> operated  
 by Rx sync. switch  
 on EPIDH

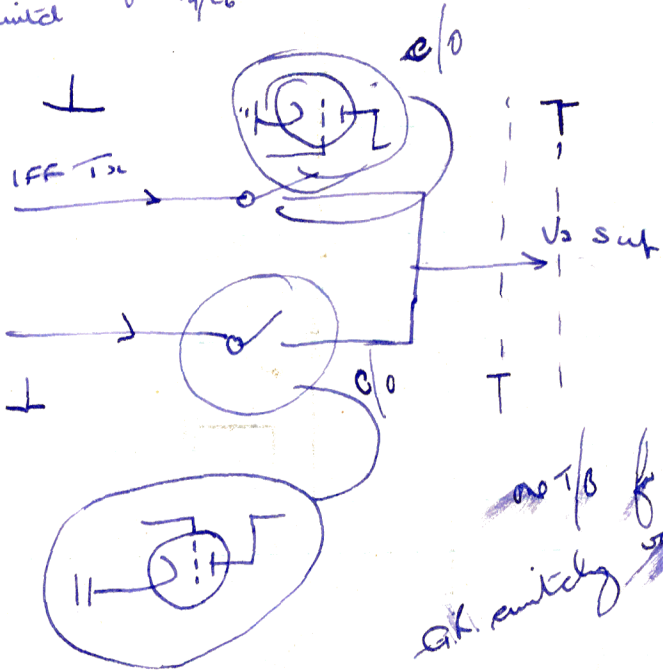

no T/O for each cycle  
 ok. switch ~~value~~

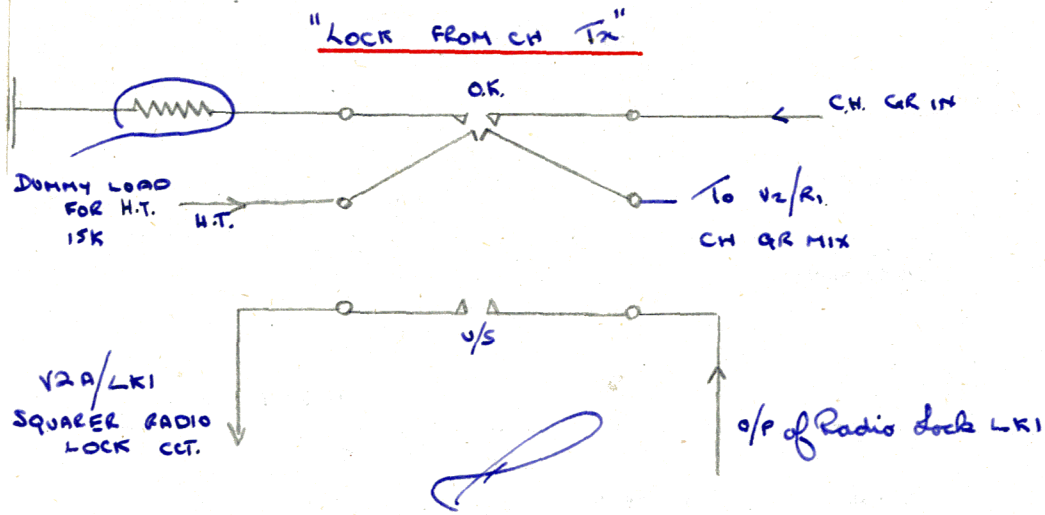

"Receiver Sync. Switch"

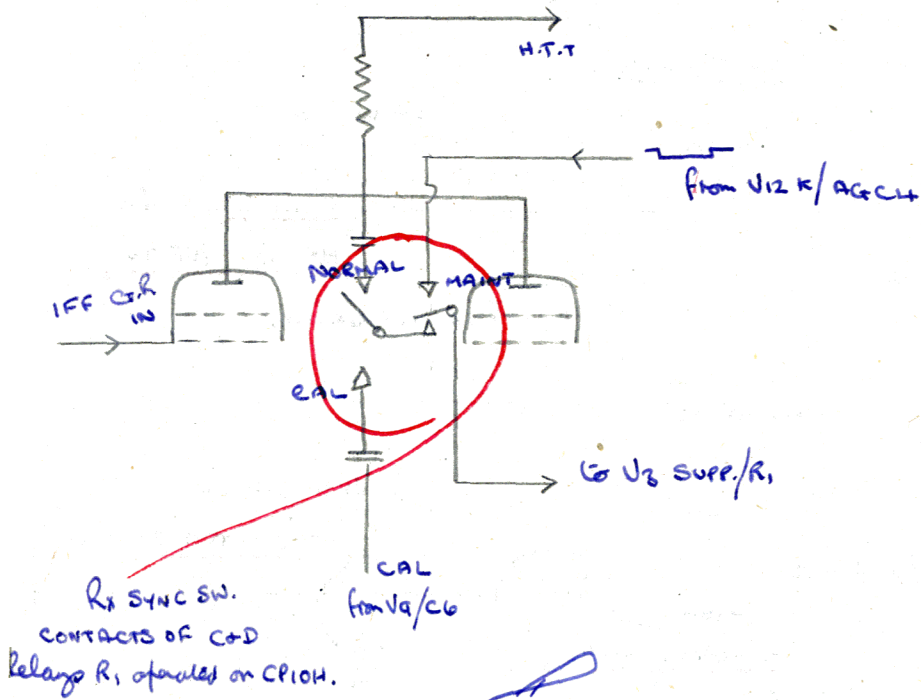

MAIN RECEIVER UNIT

AERIAL RECEIVERS:

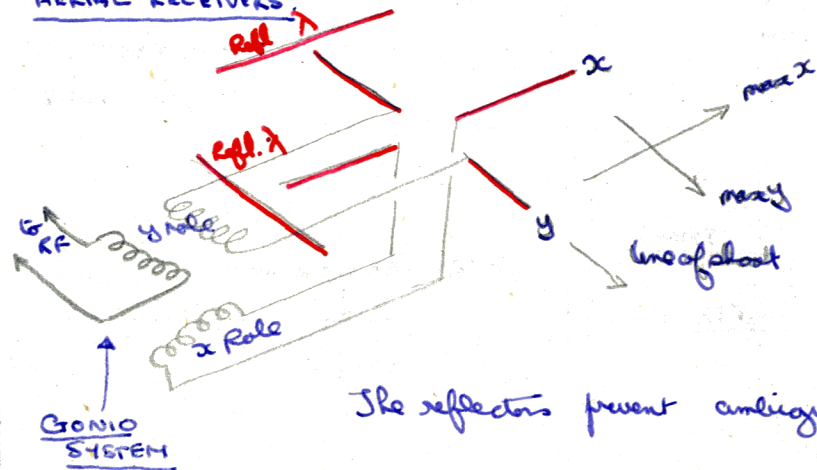

Gap filling methods are used i.e. arrays, similar to above 'A' system at 215', at 95' [B system] and 45' [C system]

GONIO LAYOUT

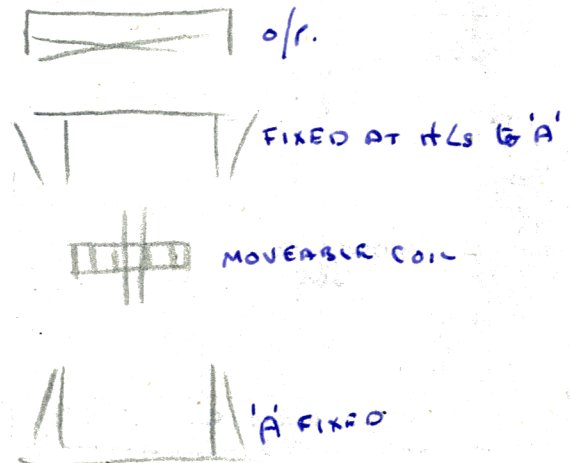

ACTION:

Movable coil is rotated



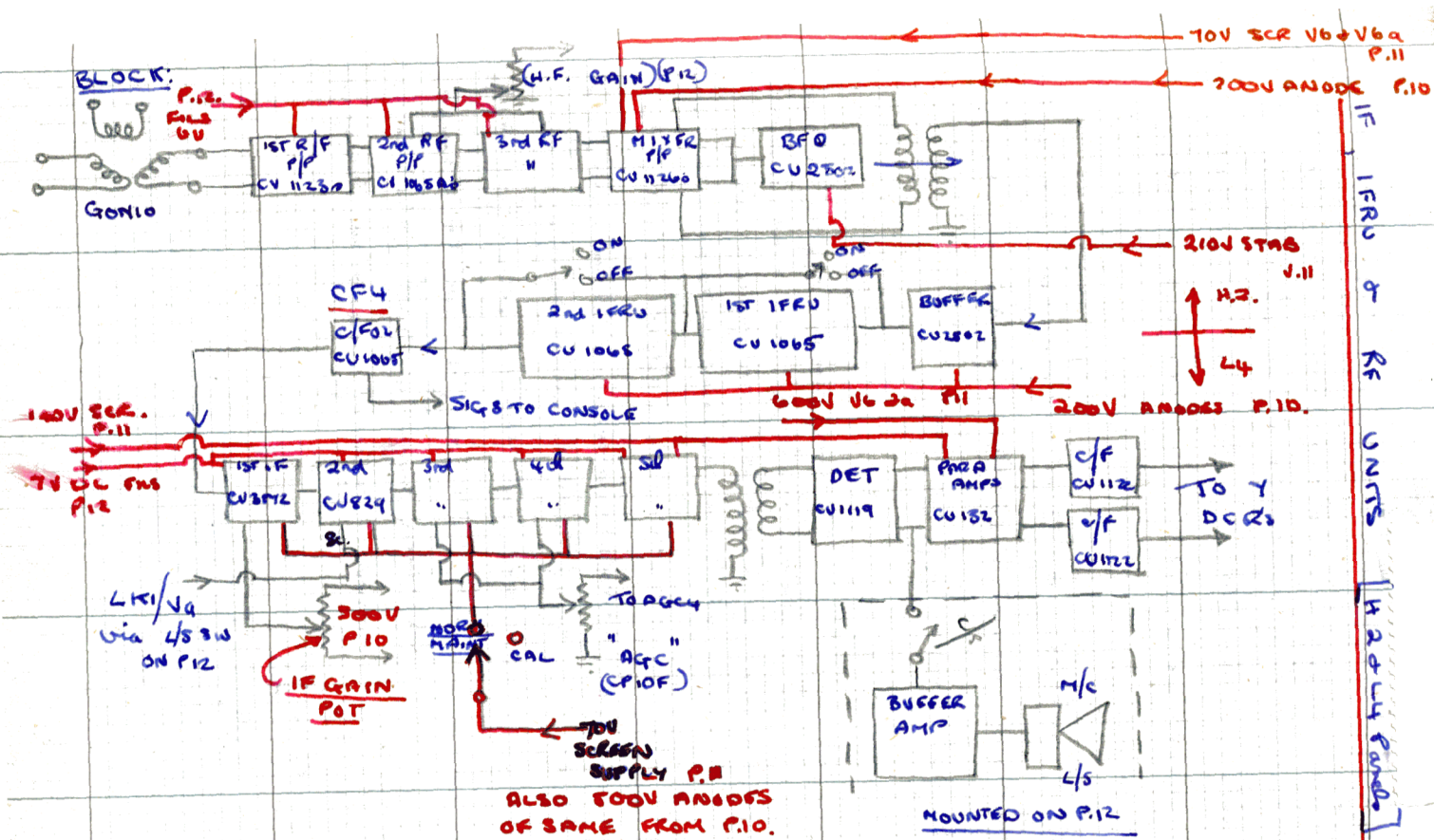

RECEIVER CHAIN:

SUCCINCT DETAILS:

RF STAGES: RANGE 20-60 Mc/s in 4 bands

- i) 20-30 Mc/s
- ii) 30-38
- iii) 32-50
- iv) 40-60

Bandwidth 500 Kc/s

IF Rejection Units

minimum rejection units; two bands of 8 Kc/s

IF Amps.

Frequency 2 Mc/s, 3 bandwidth of:-

- i) 50 Kc/s (narrow)
- ii) 200 Kc/s (medium)
- iii) 500 Kc/s (wide)

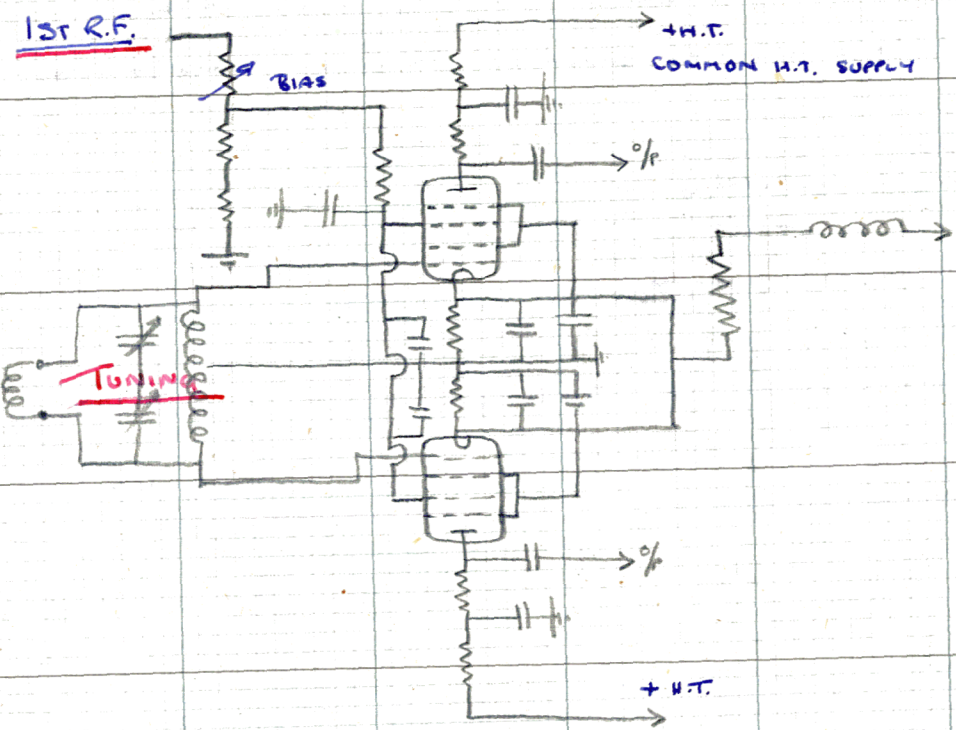

R.F. stages: Push Pull amplification throughout for symmetrical amplification and stability thus simplifying decoupling. Input stage provides balanced connections for goni search coil.

1st RF: Employs special H.F. Hexode having small slot raised. a grid maintained at cathode potential concentrates electrons passing through into beams directed to pass through apertures in the screen with a great consequent large reduction in screen current. Isolating the input circuit from the heat generated by the valves minimises the noise due to thermal agitation.

Large amplitude ground ripples are prevented paralyzing the amp. by passing a stabilised D.C. through the cathode bias resistances. The effect of this current is to swamp any variations in grid bias produced by varying  $I_{a0}$ . The 60 W.F electrolytics, shunting the bias resistances, ~~present~~ present a large pure resistance at H.F. or to H.F. They are therefore bypassed by small mica condensers which are connected across them.

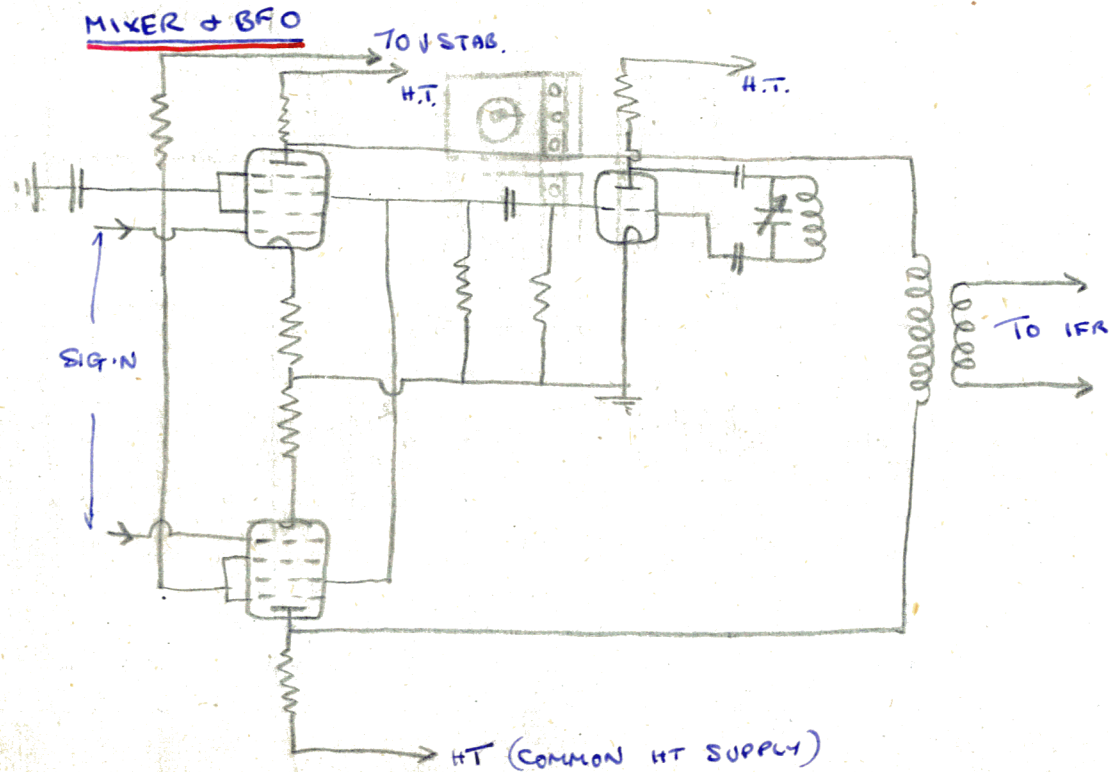

ACTION: Push to sig i/p lowers the possibility of the o/p being pulled into step by the signal i/p. Mixer valves are operating  $180^\circ$  out of phase and should the local oscil. be pulled off frequency on one half cycle it will be cancelled out when the other valve conducts. Noise level is also reduced since the BFO is minimized or balanced out in the IF output circuit.

Oscillator: modified Colpitts o/p taken across grid and cathode. The coupling for oscillator maintenance being effected by stray capacity and interelectrode capacity of the valve.

1ST IFRU

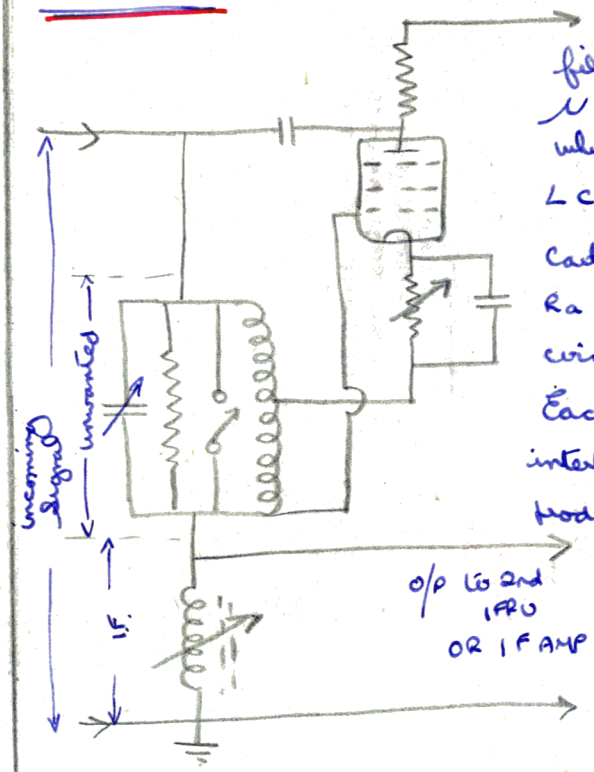

Incoming signal applied across filter consisting in core inductance  $\mu$  tuned to IF and an LC circuit which may be tuned to the unwanted signal. LC circuit is in effect a Hartley Osc. Cathode resistance which is in varying the  $R_a$  of the valve varies damping in the circuit with resultant control of selectivity. Each filter may be tuned to separate interfering signals or both used to provide rejection of narrow band frequencies.



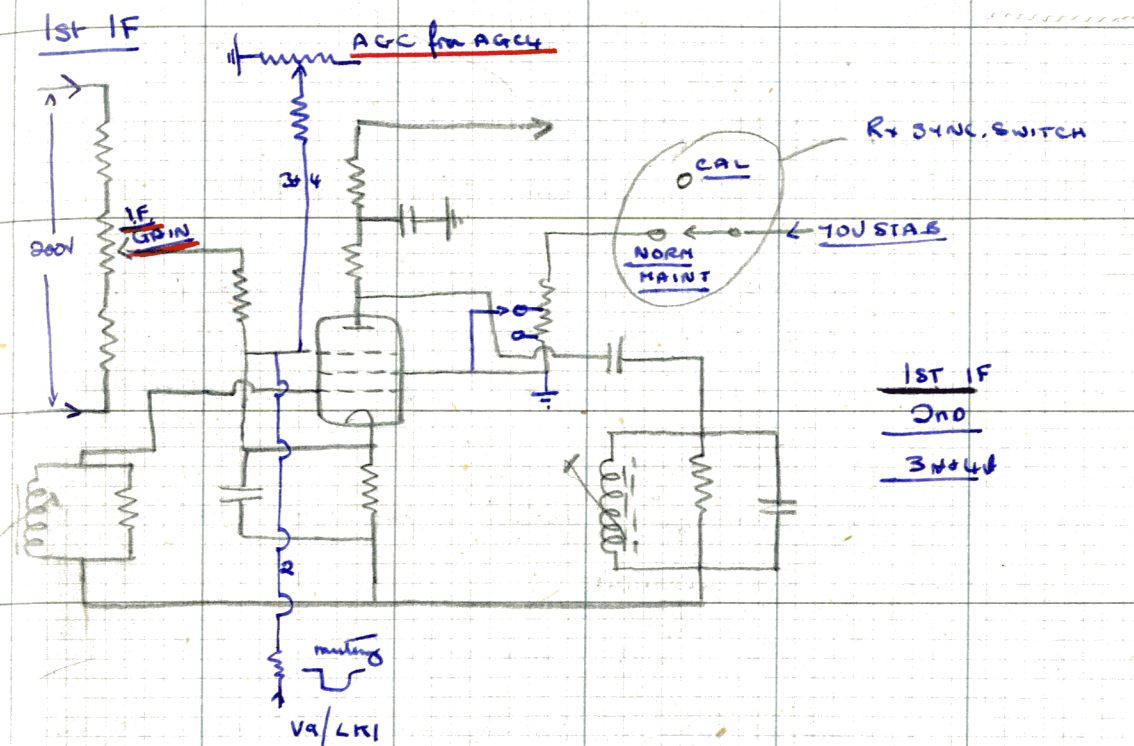

IFS: Each bandwidth has separate tuned circuit; tuned "in line" on narrow; "stagger tuned" with damping on medium, and wide "stagger tuned" with damping resistance on wide. When wide bandwidth selected the coupling condensers are also changed. Normal working on medium bandwidth for best signal/noise ratio with least signal distortion.

GAIN SWITCH: Shunts a fixed resistance in the 70V screen supply to provide a rapid and fixed change in gain.

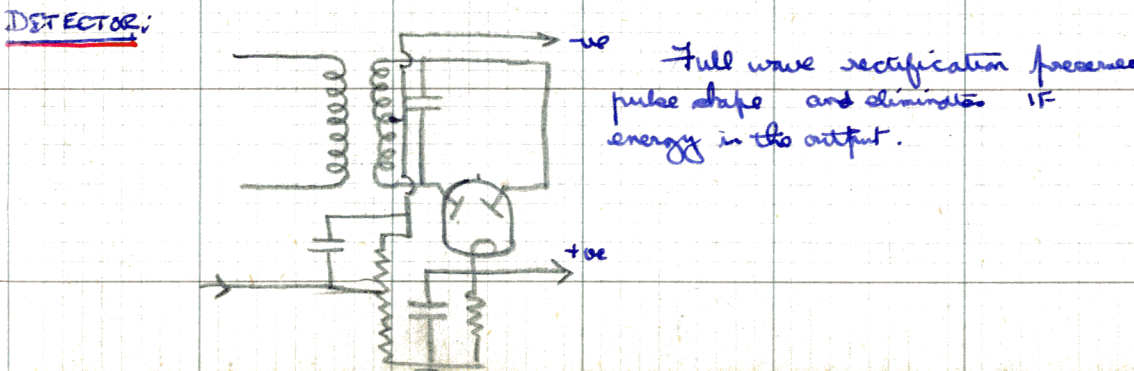

PARAPHASE AMPS:

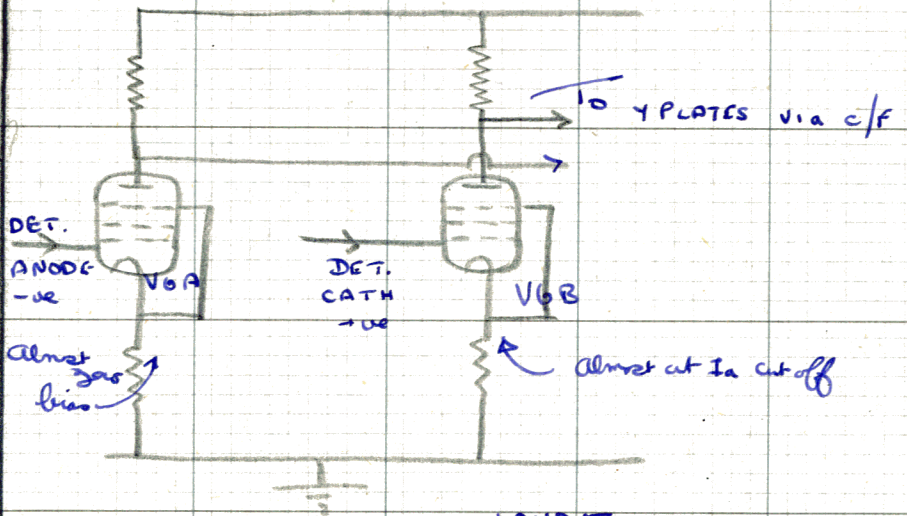

LAYOUT

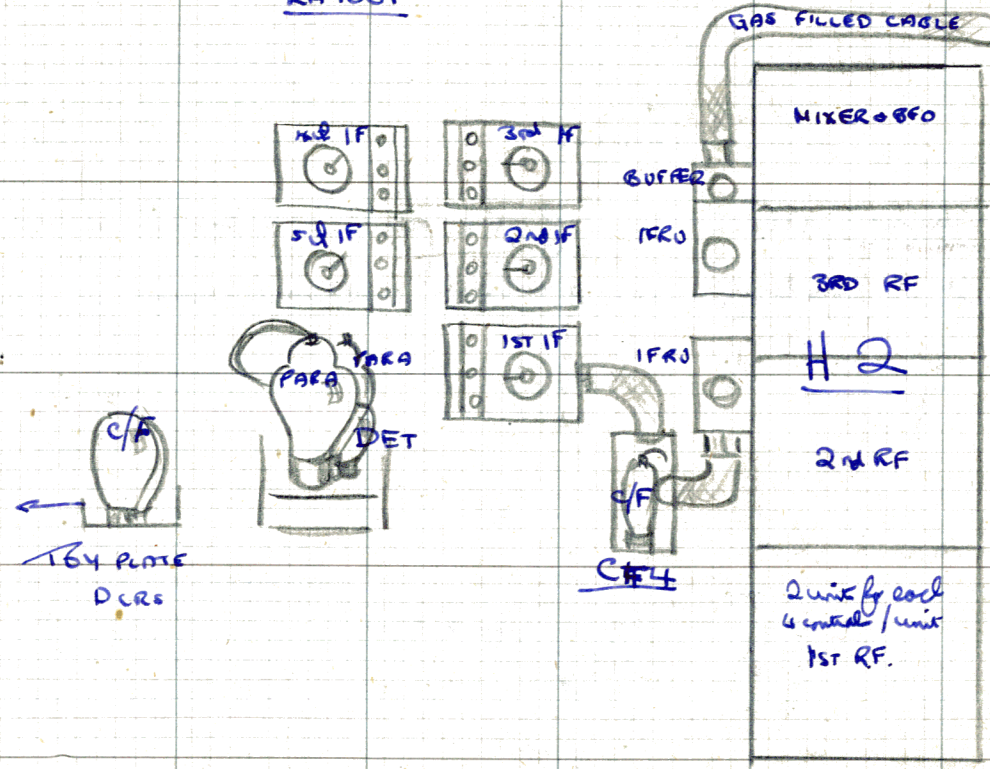

ABSOLUTE POWER SUP. IF GAIN



SPEAKER CIRCUIT

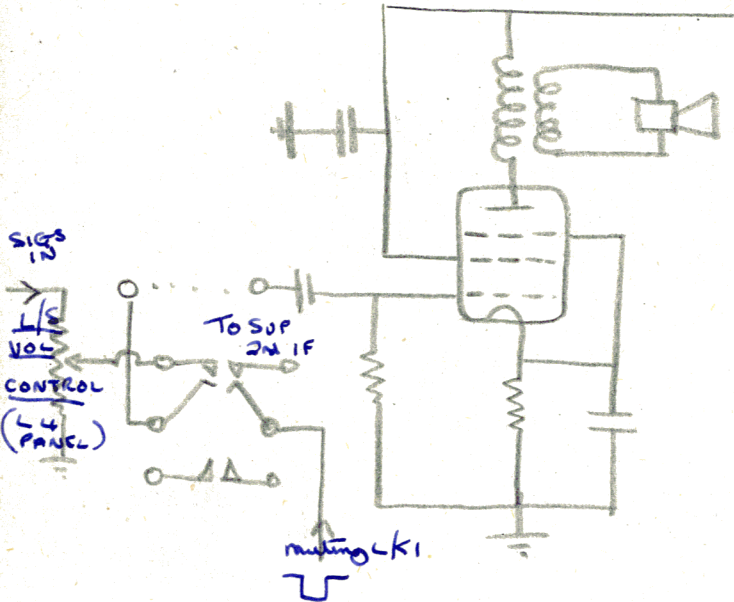

PURPOSE:  
To provide aural means of interference identification. When switched on muting pulses removed so that signals are not modulated by the 25c/s muting pulses

PHASING CIRCUIT

Purpose: Alter phase of T2 relative to another in the CH system if it is interfering. It is a network such as follows:-

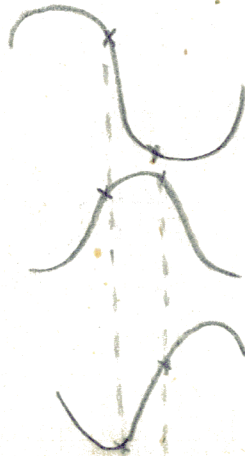
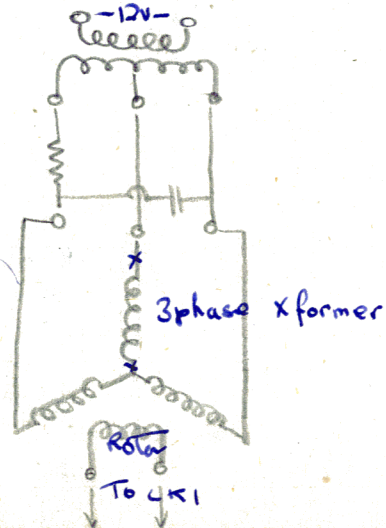

POWER SUPPLIES:

SEE BLOCK DIAGRAM.

WAVEFORMS: NONE NECESSARY.

SW CONTROLS: "H.F. GAIN": varies SCREEN potential of RF valves 2nd and 3rd.

"TUNING": grid and anode tuned circuits of all RF

(IFRU) ~~RF~~ "TUNING": unwanted sig IFRU

(IFRU) "IFRU ON OFF": for either IFRU circuit or both, the switches shut out either IFRU circuit.

(IFRU) "R of CATHODE": varies damping of tuned circuit for unwanted sig this selectivity.

(BEAR) [PRESET] "TUNING": IF of ~~unwanted sig~~ see IFRU note

(CP10F) "AGC CONTROL": On suppressors of ~~1st~~ 2nd & 4th IF varies input from AGC4. this AGC on IF value.

(CP10F) "IF GAIN": varies suppressor and cathode of 1st IF

(L4) "GAIN SWITCH": MENTIONED PREVIOUSLY

SCOPE PTS.: None.



POWER SUPPLIES

P10, 11 & 12

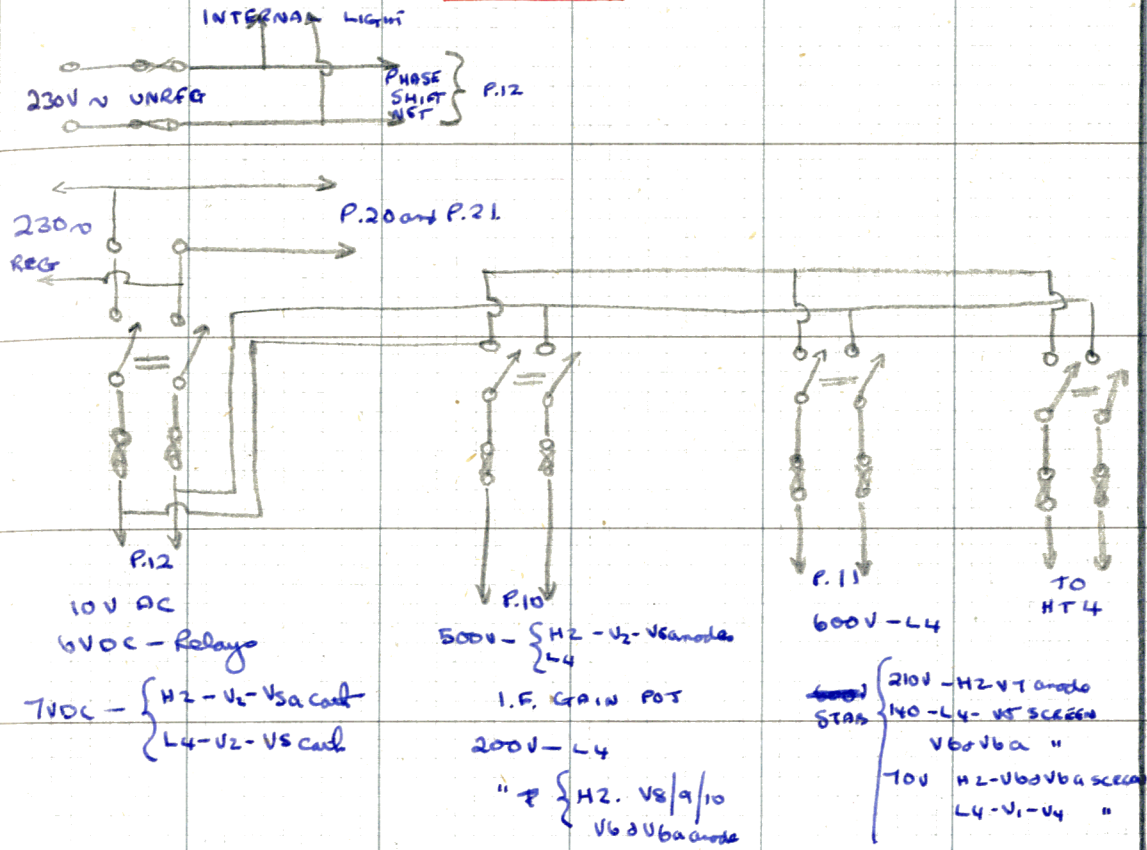

P20 & 21

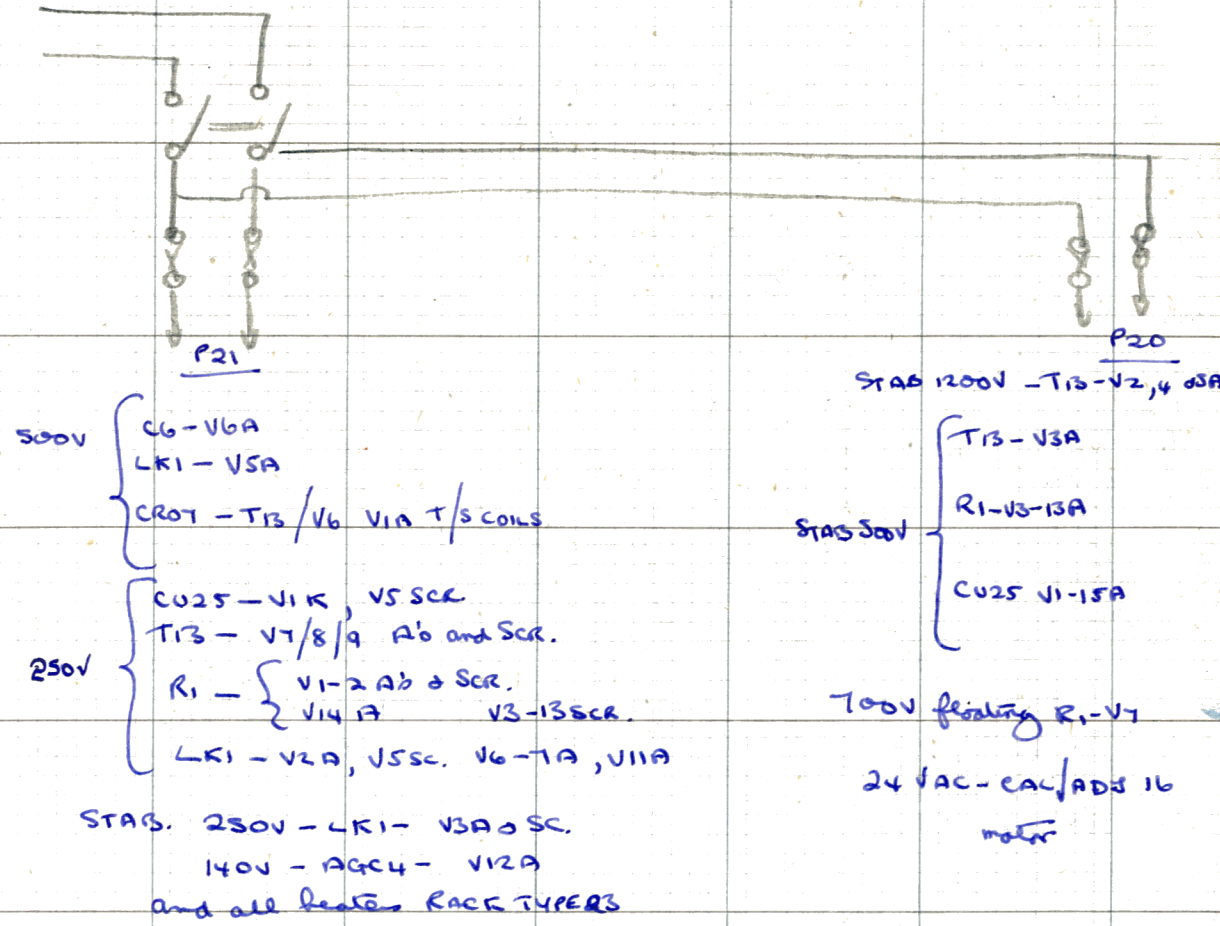

DIPLOLE CONSOLE TYPE 2/3

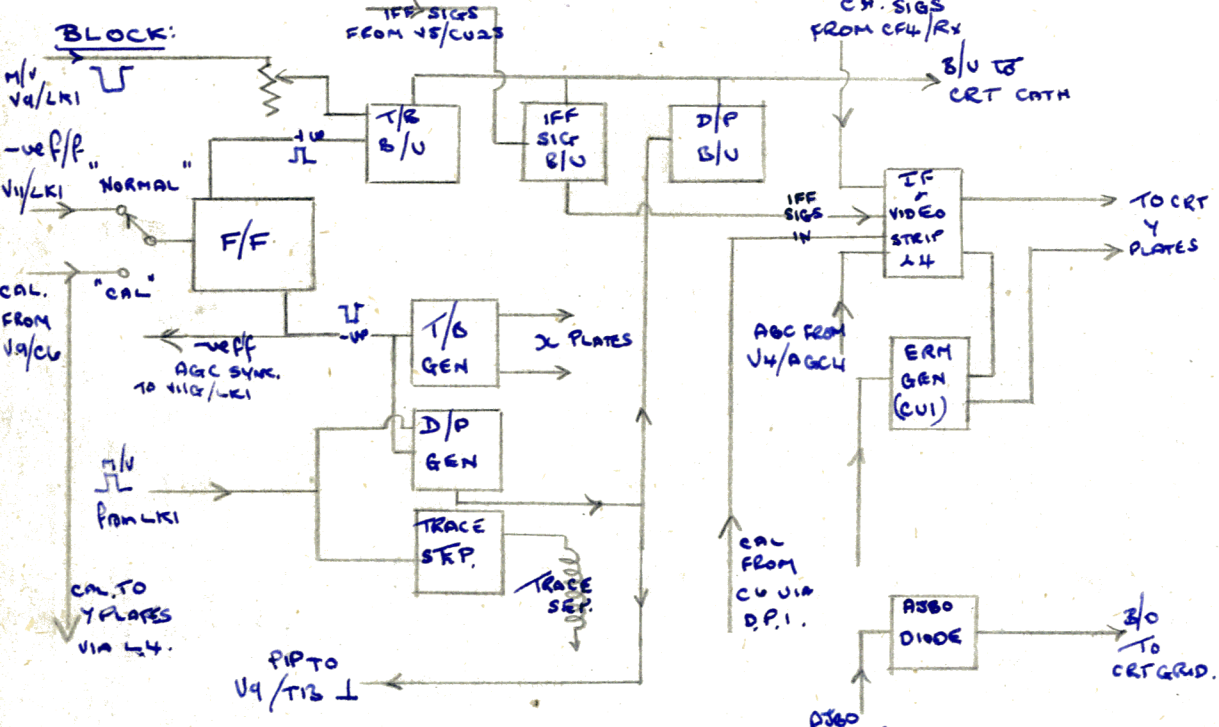

PURPOSE (i) A liaison with CH receives operator and pleaters ie D/P indicates signal required knowledge of  
 (ii) Timing of lines

D.P.I. PANEL

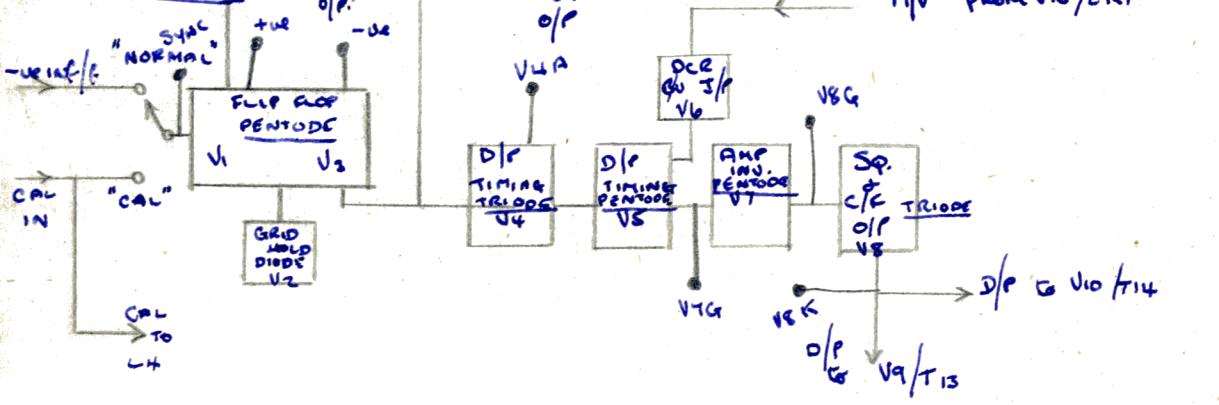

V1 CONSOLE FLIP/FLOP

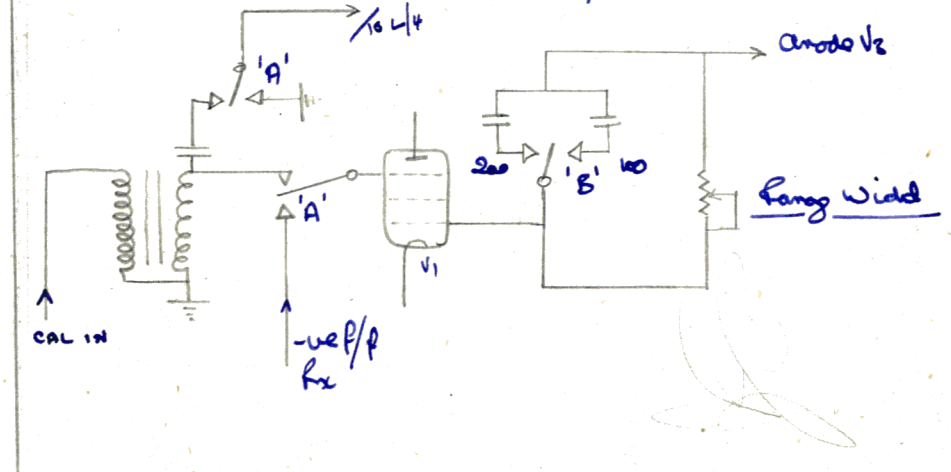

D/P circuit [simplified]

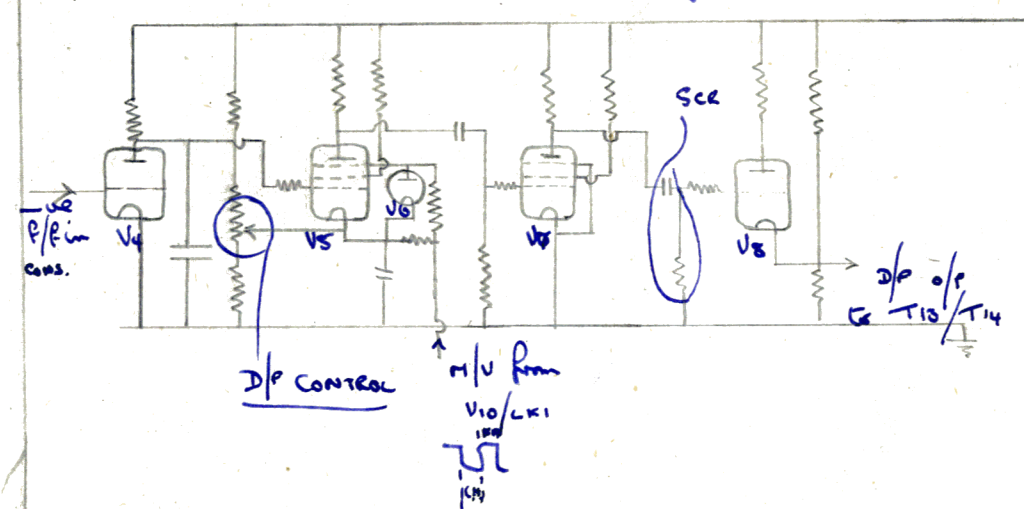

ACTION: Director Pulse gate.  
 V4: is normally conducting and V5 cut off by a voltage determined by the setting of the "D/P control". The -ve f/p pulse applied to V4 grid cuts its valve off producing a true going exponential at its anode due to the charging of the condenser C.



When the amplitude of that voltage is such that it cuts on V5, the leading edge of the anode voltage of V5 is retarded on that of the flip/flop waveform by an amount set by the negative bias on V5 grid. That bias being variable produces a waveform of varying width in the anode.

The anode waveform of V5 is amplified and phase inverted by V7 and applied to the output valve V8 via a short CR. V8 operates as 1) a squarer, being biased beyond cut off and its grid prevented from swinging +ve by the grid stopper.

2) as a cathode follower feeding the D/P to T14 and T13 to trigger the D/P trigger up circuit. The o/p waveform is approx 5µsec wide.

During CH T/B's V5 is cut off on its suppressor grid by the M/V output from V10/LK1. Which is fed via the DCR V6, as the M/V o/p is -ve going with respect to earth and the sup. of V5 having to be brought almost to cathode potential at least before V5 will conduct during the IFF time period.

WAVEFORMS:

CONSOLE TUBE PANEL

